

**SOVET**  
ITALIA

**SOVET**  
ITALIA

Sovet was born at the end of the '80s to explore the expression possibilities of glass in the contemporary furnishing. Since the beginning of the years 2000 it starts the collaboration with important international designers and introduces other materials alongside glass, widening its perspective under the sign of creativity and continuous evolution. From “New shapes for glass” to “New shapes for design”, in the last 30 years the company has undergone a constant growth, transforming itself from a company identified with glass to an internationally successful 360-degree design company, with new solutions both for home and contract environment which combine minimalism and an accurate materials selection.

Sovet nasce alla fine degli anni '80 per esplorare le possibilità espressive del vetro nell'arredo contemporaneo. Dai primi anni 2000 intraprende la collaborazione con importanti designers internazionali e affianca al vetro altri materiali, ampliando la propria ricerca nel segno della creatività e dell'evoluzione continua. Da “New shapes for glass” a “New shapes for design”, negli ultimi 30 anni l'azienda ha visto una costante crescita per trasformarsi da un'azienda identificata con il vetro ad un'azienda di design a 360 gradi, affermata sempre di più nel panorama internazionale con nuove soluzioni per l'home e il contract che coniugano un ricercato minimalismo con un'attenta selezione dei materiali.



# heritage

The creative use of industrial processes, the use of raw materials of absolute quality and the scrupulous work of master craftsmen, allow Sovet to create high quality and 100% Made in Italy collections. Thanks to state-of-the-art industrial automation systems, Sovet is able to meet also large supply needs for contract spaces, always granting the highest quality standards. The company takes a continuous search path for materials, to create an offer of accessories complementing one another, furnishing different kinds of environments with the maximum customization possibility.

L'impiego creativo dei processi industriali, l'utilizzo di materie prime di assoluta qualità e le scrupolose lavorazioni eseguite da maestranze artigiane, permettono a Sovet di ottenere collezioni di alta qualità e 100% Made in Italy. Grazie a sistemi di automazione industriale all'avanguardia Sovet è in grado di soddisfare anche esigenze per grandi forniture destinate a spazi contract, sempre garantendo i più elevati standard qualitativi. Sovet intraprende un percorso di ricerca dei materiali per creare un'offerta di complementi che si integrino tra di loro, arredando varie tipologie di ambienti con la massima possibilità di personalizzazione.

**made  
in Italy**



## material innovation/ sustainability

Glass keeps its value as a fundamental element for Sovet. The glass is conjugated and processed with the most advanced technology and creates new materials, which combine research and know-how, like the Materia and the Liquid glass. The widening of the product types range and the continuous devotion aimed at offering to the public more and more custom possibilities are key points to Sovet, which led to the selection of more than 123 finishes. From ceramic to wood, from HPL to the Cristalplant, to steel and aluminum. Leathers, fake leathers, velvets and fabrics complete a selection of fine finishes, all made in Italy.

Glass can be reintroduced in the production cycle countless times and it is strongly representative of the high attention the company has towards the eco-compatibility. For its production processes Sovet uses energy coming directly from renewable sources. Thanks to its photovoltaic systems it is able to meet its own energy demand. Furthermore, the company uses cardboard packaging with limited presence of oil-derivates and water-based paintings for lacquering.

Il vetro rimane un elemento fondamentale per Sovet. Un vetro che viene declinato e lavorato con le tecnologie più avanzate creando nuove espressioni che coniugano ricerca e know-how, come il Materia e il Liquid Glass. L'ampliamento della gamma di tipologie di prodotti e la continua ricerca volta ad offrire ai clienti sempre più possibilità di personalizzazione sono dei punti fondamentali che hanno portato alla selezione di oltre 123 finiture. Dalla ceramica, ai legni, dall'HPL al Cristalplant, all'acciaio e l'alluminio. Pelli, ecopelli, velluti e tessuti completano una selezione di pregiate finiture, tutte made in Italy.

Il vetro può essere reintrodotta nel ciclo produttivo infinite volte ed è quindi rappresentativo dell'elevata attenzione dell'azienda nei confronti dell'ecocompatibilità. Per la sua produzione Sovet utilizza infatti energia derivante direttamente da fonti rinnovabili. Attraverso impianti fotovoltaici riesce a soddisfare il proprio fabbisogno energetico. Inoltre usa imballi di cartone costruiti ad hoc con limitata presenza di derivati del petrolio ed impiega vernici all'acqua per le lavorazioni.

One of the main values for Sovet is the design intended as mean to express innovation and a new culture of living the spaces. The important collaborations with studios and designers of international renown like Altherr Desile Park, Lievore Altherr Molina, Studio Irvine, Matthias Demacker and Gianluigi Landoni led to the creation of unique collections characterized by a contemporary and minimalistic feeling. A range that offers several furnishing choices, dimensions and colours, always with a focus on timeless essentiality.

Uno dei principali valori per Sovet è il design, inteso come strumento attraverso il quale esprimere innovazione ed una nuova cultura dell'abitare gli spazi. Le importanti collaborazioni con studi e designers di fama internazionale come Altherr Desile Park, Lievore Altherr Molina, Studio Irvine, Matthias Demacker e Gianluigi Landoni hanno portato alla creazione di collezioni uniche dal sapore contemporaneo e minimalista. Una proposta che offre una vasta possibilità di scelta fra tipologie d'arredo, dimensioni e colori, sempre nel segno di un'essenzialità che va oltre il tempo.

development/  
design



The know-how in the production phase and materials processing, together with the excellence of the «custom» technical service developed in time, led Sovet to collaborate more and more with architectural studios of international renown for the development of residential and contract projects all around the world and the furnishings of restaurants, hotels, lounge areas, airports, ships and commercial spaces.

Il know-how nella produzione e nella lavorazione dei materiali, unito all'eccellenza del servizio tecnico e progettuale «custom» sviluppato negli anni, hanno condotto Sovet a collaborare sempre di più con studi di architettura di fama internazionale per lo sviluppo di progetti residenziali e contract in tutto il mondo e l'arredamento di interni di ristoranti, hotel, lounge area, aeroporti, navi, spazi comuni e commerciali.



**bespoke**

# designers



## Studio Lievore Altherr Molina

Lievore Altherr Molina, was founded by Alberto Lievore, Jeannette Altherr and Manel Molina in 1991. The Studio focuses on product design, consultancy and art direction work for a number of companies, offering personalized solutions to industry. Known by its furniture design, it also develops interior design projects, packaging and product design. In many opportunities, the Studio gives seminars and courses cooperating with several Spanish universities in forming new professionals.

Lo Studio Lievore Altherr Molina è composto da Alberto Lievore, Jeannette Altherr e Manel Molina, che hanno formato una società nel 1991. Lo Studio si dedica all'industrial design, alla consulenza e all'art direction di diverse aziende, offrendo soluzioni personalizzate. Conosciuto per i suoi progetti di design di prodotto, sviluppa inoltre progetti di design d'interni, packaging e industrial design. A tali attività vanno aggiunte la docenza esercitata in seminari, workshop e conferenze, presso diverse Università spagnole aiutando la formazione di nuovi professionisti.



It currently works for firms in Spain, Italy and the United States, outstanding its projects for international renowned companies. Award-winner with Spanish National Design Award (1999) it has received numerous awards and special mentions, both in Spain and abroad, for its work, including several ADI-FAD Deltas Gold and Silver. It has held both individual and joint exhibitions in Barcelona, Cologne, Chicago, Stockholm, Helsinki, Lisbon, London, Louisiana, Madrid, Malmö, Milan, New York, Paris and Tokyo. Its designs are featured regularly in Spanish and international trade magazines.

Attualmente svolge attività in Spagna, Italia e Stati Uniti, collaborando con aziende di fama internazionale. Lo studio ha ricevuto numerosi premi e riconoscimenti nazionali e internazionali per i lavori svolti, tra cui il Premio Nacional de Diseño (1999) e diversi Delta de Oro e Delta de Plata dell'ADI-FAD. Ha realizzato mostre personali ed esposizioni a Barcellona, Colonia, Chicago, Stoccolma, Helsinki, Lisbona, Londra, in Louisiana, a Madrid, Malmö, Milano, New York, Parigi e Tokyo. I lavori vengono pubblicati regolarmente su tutte le riviste specializzate nazionali ed estere.

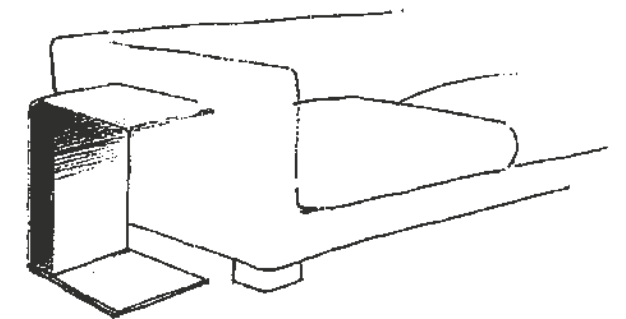
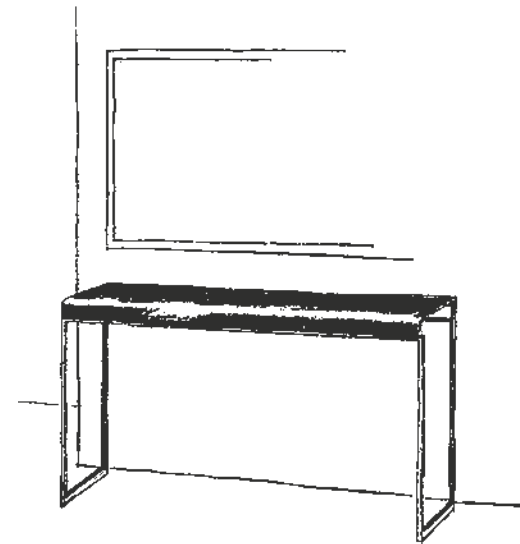

# Gianluigi Landoni

Gianluigi Landoni, graduated in architecture at Politecnico di Milano, in 1985 was the co-founder of the design trend group Amalgama. Project manager at Rodolfo Bonetto's studio. He has carried out his own professional activity as a consultant to "design oriented" companies in various productive sectors and he founded with Rosaria Sofia Galli ALTROdesign multidisciplinary studio. At the same time he works on set-ups and realizations for furnishing companies in the hotel and commercial sector. He has also attended in exhibitions and competitions, receiving prizes and awards, not least the report to the 1991 edition of the Compasso d'Oro and subsequent Premio Compasso d'Oro in the 1998 edition.

Gianluigi Landoni si è laureato in architettura al Politecnico di Milano, nel 1985 ha fondato il gruppo di tendenza di design "Amalgama". Ha lavorato per lo studio Rodolfo Bonetto. Ha anche fondato lo studio multidisciplinare ALTROdesign con Rosaria Sofia Galli. Svolge l'attività professionale in proprio come consulente ad aziende "design oriented" in vari settori produttivi, e si occupa parallelamente di allestimenti e realizzazioni per aziende di arredamento nel settore alberghiero e commerciale. Ha inoltre partecipato a numerose mostre e concorsi, ricevendo premi e riconoscimenti, non ultima la segnalazione all'edizione 1991 del Compasso d'oro e successivo Premio Compasso d'oro nell'edizione del 1998.

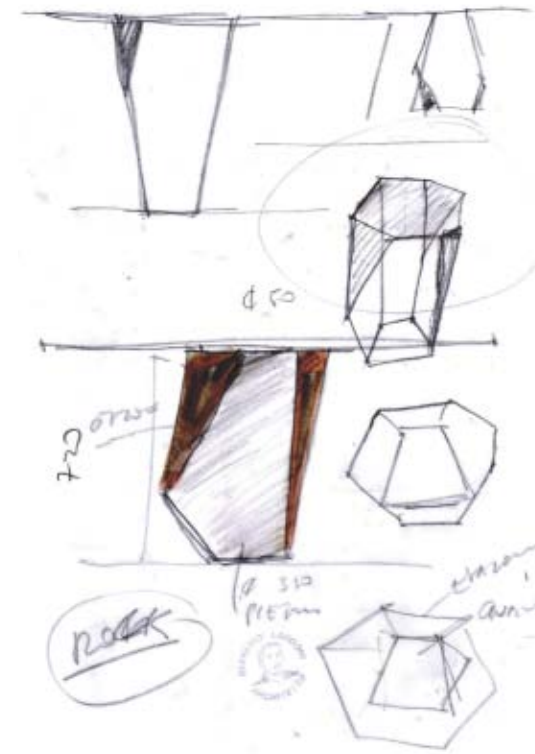

As a designer I see in the "project" the answer to the specific needs that emerge in the daily space-living experience. For me it is important to develop the idea, to focus on the execution and production process phases to minimize efforts and waste in both process and material. I like to create a product that expresses the production know-how of the company through itself and its stylistic and aesthetic language. Glass has been the starting point for the first projects developed together with skilled craftsmanship and advanced technology, two key points that have always been characterizing the company. In the last years together, we started a research and development path to give shape to a new concept of living the space, with new materials and products. We like to feed the creativity with different sources of inspiration exploring new project ideas and solutions that could lead us to new space-living horizons.

Come designer, vedo nel progetto la soluzione alle specifiche esigenze che emergono nella quotidianità dell'abitare gli spazi. In me prevale sempre l'attitudine a sviluppare l'idea e concentrarmi sulle fasi del processo produttivo ed esecutivo, cercando di minimizzare gli sprechi di processo e di materiale. Mi piace pensare ad un prodotto che esprima il know-how produttivo aziendale attraverso sé stesso ed il linguaggio stilistico ed estetico che lo compone. Per Sovet il vetro è stato punto di partenza dei primi progetti sviluppati assieme con sapienza artigianale e tecnologie avanzate, due valori che da sempre distinguono l'azienda. Negli ultimi anni assieme abbiamo intrapreso un percorso di ricerca e sviluppo per dare forma ad un nuovo concetto di abitare gli spazi, attraverso nuovi materiali e prodotti. Ci piace nutrire la creatività con diverse fonti d'ispirazione, andando ad esplorare nuovi pensieri progettuali e soluzioni che portino a nuovi orizzonti per l'abitare.



## Altherr Desile Park

Jeannette Altherr, Delphine Désile and Dennis Park are a collective of professionals collaborating across different constellations. The Barcelona-based studio specializes in product design & development, strategic consulting, creative direction, art direction, and ephemeral architecture for internationally recognized design companies. The studio develops projects using an established strategy: a creative concept integrating product design and its communication. This holistic approach, humanist character, and the search for the essential in their projects – combined with a sensibility that transmits harmony and balance – characterize the designs of Altherr Désile Park.

Jeannette Altherr, Delphine Désile e Dennis Park sono un collettivo di professionisti che collaborano attraverso differenti costellazioni. Lo studio, situato a Barcellona, è specializzato nel product design & sviluppo, nella consulenza strategica, nella direzione creativa e artistica e nell'architettura per rinomate aziende di design internazionali. Lo studio sviluppa progetti usando una strategia stabilita: un concetto creativo di integrazione del prodotto e della sua comunicazione. Questo approccio olistico, dal carattere umanista e la ricerca dell'essenziale nei loro progetti – combinata con una sensibilità che trasmette armonia ed equilibrio caratterizzano il design di Altherr Désile Park.



Sovet's main materials - glass and metal - are noble materials that combine very well with common architectural materials such as stone and concrete. For the Campos collection we were wondering how to treat a mirror as a surface, avoiding the "hole in the wall" effect that regular mirrors generate. We translated this concept into a geometric interplay of coloured fields.

Different colour shades of mirrored glass and metal are combined in a graphic composition, transforming the mirrors into objects that could stand for their own beyond their purely reflecting function. The colours range is from soft and warm - copper and brass - to black, while the metal frames comes in brass, mocha or in black.

I materiali principali di Sovet - vetro e metallo - sono materiali nobili che si combinano con i principali materiali architettonici come la pietra ed il cemento.

Per il progetto della collezione Campos stavamo pensando a come trattare lo specchio come una superficie, evitando l'effetto "buco nella parete" che gli specchi comunemente creano. Abbiamo tradotto questo concetto in un gioco geometrico di campi colorati. Differenti sfumature di vetro specchiato e metallo, sono combinati in una composizione grafica che trasforma lo specchio in un oggetto che può vivere da solo aldilà della pura funzione di riflessione. La gamma di colori varia da quelli più tenui ai più caldi - rame e oro - fino al nero, mentre la cornice è in ottone, caffè o nero.



## Matthias Demacker

Matthias Demacker was born in southern Germany in 1970. He studied Design at FH Niederrhein in Krefeld and at the same time worked with different architecture firms for the design and the set up of exhibition booths.

After graduating, he moved to Munich, worked for different interior design studios and in 2003 founded his own one. He has received many international awards; among these, the Interior Innovation Award, the Nomination for the German Designpreis in 2005, the Red Dot 2007 and the Good Design Award 2010.

Matthias Demacker nasce nel sud della Germania nel 1970. Studia Design al FH Niederrhein di Krefeld e allo stesso tempo collabora con diversi studi di architettura nella progettazione e nell'allestimento di stand presso fiere ed esposizioni. Dopo la laurea si trasferisce a Monaco ed inizia a lavorare per diversi studi di interior design fino a che, nel 2003, fonda il proprio. Riceve diversi riconoscimenti a livello internazionale tra i quali: the Interior Innovation Award, la nomina per il Designpreis tedesco nel 2005, il Red Dot 2007 e il Good Design Award nel 2010.



Through a path of material deconstruction, I have obtained essential and minimal lines able to create a versatile structure, that can be integrated in different interior spaces regardless of their styles. This is the Slim concept, a versatile and at the same time multifunctional collection thanks to the various solutions offered. From tables, coffee tables and consoles to the sofa and the upholstered benches. The collaboration with Sovet allowed me to express the project the best way possible, using the aluminum to create the Slim structure with an engineering and technological precision, thanks to the company know-how in the furnishing design. The dialogue led us to the creation of an icon of the brand, recognizable in both domestic and contract projects all over the world.

Attraverso un percorso di destrutturazione della materia sono giunto a ricavare delle linee essenziali e minimali che permettessero di creare una struttura versatile e che si integrassero negli interni aldilà dello stile di questi.

Questo è il concept di Slim, una collezione versatile ed allo stesso tempo multifunzione grazie alle varie soluzioni proposte. Dai tavoli, tavolini e console fino ad arrivare al divano e alle sedute. La collaborazione con Sovet mi ha permesso di esprimere al meglio il progetto, realizzando la struttura Slim in alluminio con precisione ingegneristica e tecnologica che fonda le radici nel Know-how aziendale nella progettazione d'arredo.

Il dialogo ha portato alla creazione di un'icona del brand, riconoscibile in spazi abitativi e progetti in tutto il mondo.

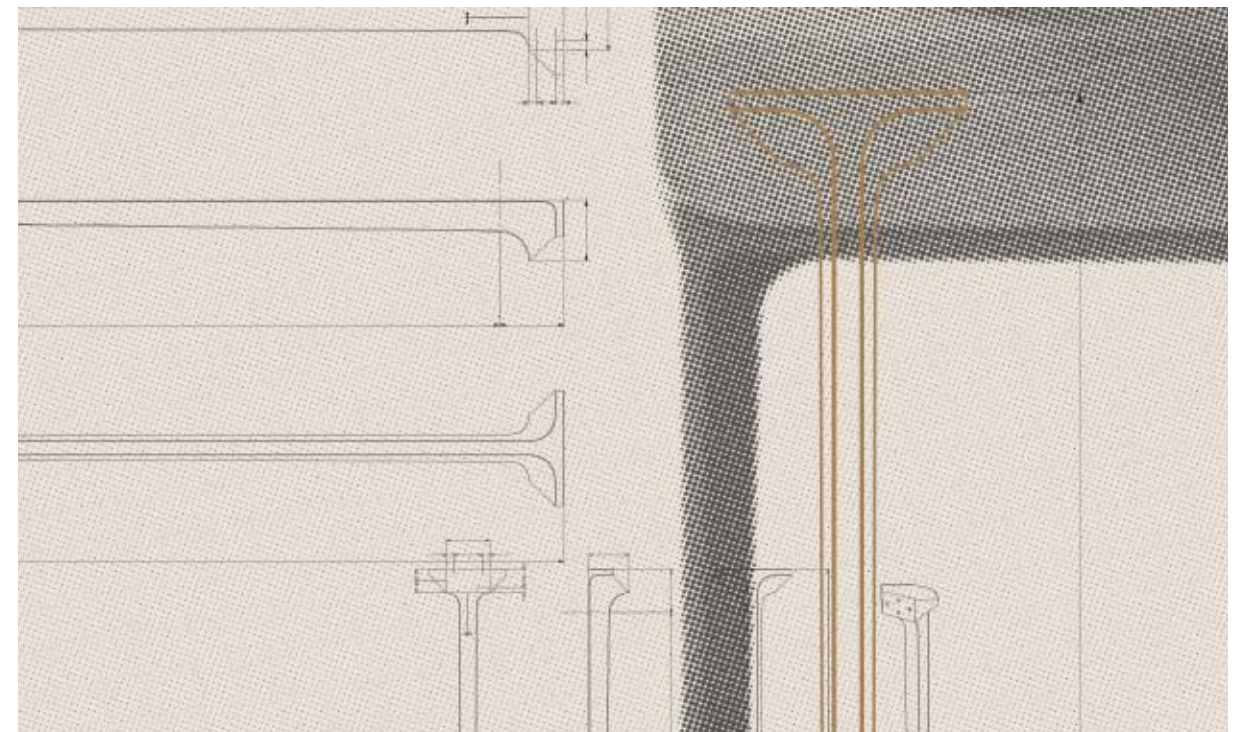

## Studio Irvine Marialaura Rossiello

Studio Irvine is a design studio based in Milan and run by the architect Marialaura Rossiello Irvine. Founded in 1988 by British designer James Irvine (1958-2013), the studio remains faithful to his design approach and method in a combination of irony and precision.

Based on the idea of design inspired by attention to ethics, the 'human factor' and personal interaction, Marialaura Rossiello is instilled with a vision in constant evolution, rooted in the classics of the Italian design school but with a broader international outlook.

For a number of years she collaborated with Italian design brands, and grew accustomed to consider the product within a comprehensive corporate process. Today her work is distinctively cross-disciplinary with a great curiosity towards all types and scales of design projects: product, interior and strategic design.

Studio Irvine è uno studio di design milanese dell'architetto Marialaura Rossiello Irvine. Fondato nel 1988 dal designer inglese James Irvine (1958-2013), lo studio è rimasto fedele al suo approccio e metodo al progetto in una combinazione di ironia e precisione.

Basato sull'idea del design ispirato ad un'attenzione all'etica, al fattore umano e all'interazione per le persone, Marialaura Rossiello ha una visione del design in costante evoluzione; partendo dai classici del design italiano con una prospettiva internazionale più ampia. Per diversi anni ha collaborato con aziende del design e si è allenata a considerare il prodotto all'interno di un processo aziendale complesso. Oggi il suo lavoro è interdisciplinare con una grande curiosità verso diverse scale di progetto: dal design di prodotto all'interior fino all'art direction.

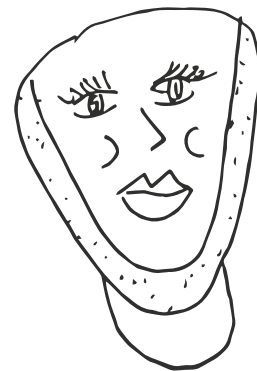

courtesy of Dior

Sovet is a symbol of minimalism and material research rigorously made in Italy. The challenge was to create a mono-material object with a personality capable of fitting in any kind of environment. Clessidra was born this way: a rounded shape given by the combination of rays of different dimensions. Thanks to the sanded effect on the edge, we drew a frame on the object itself without adding any other material or shape. Clessidra's conjugation in different versions and types was a natural evolution.

Sovet è simbolo di minimalismo e ricerca materica rigorosamente made in Italy. La sfida è stata di creare un oggetto monomaterico con una personalità in grado di adattarsi in qualsiasi ambiente. Così è nata Clessidra: una forma arrotondata data dall'incontro di raggi di diversa dimensione. Grazie ad un effetto sabbato sul bordo, abbiamo disegnato una cornice sullo stesso oggetto senza aggiunta di altri materiali o forme. La declinazione di Clessidra in diverse versioni e tipologie è stata un'evoluzione naturale.

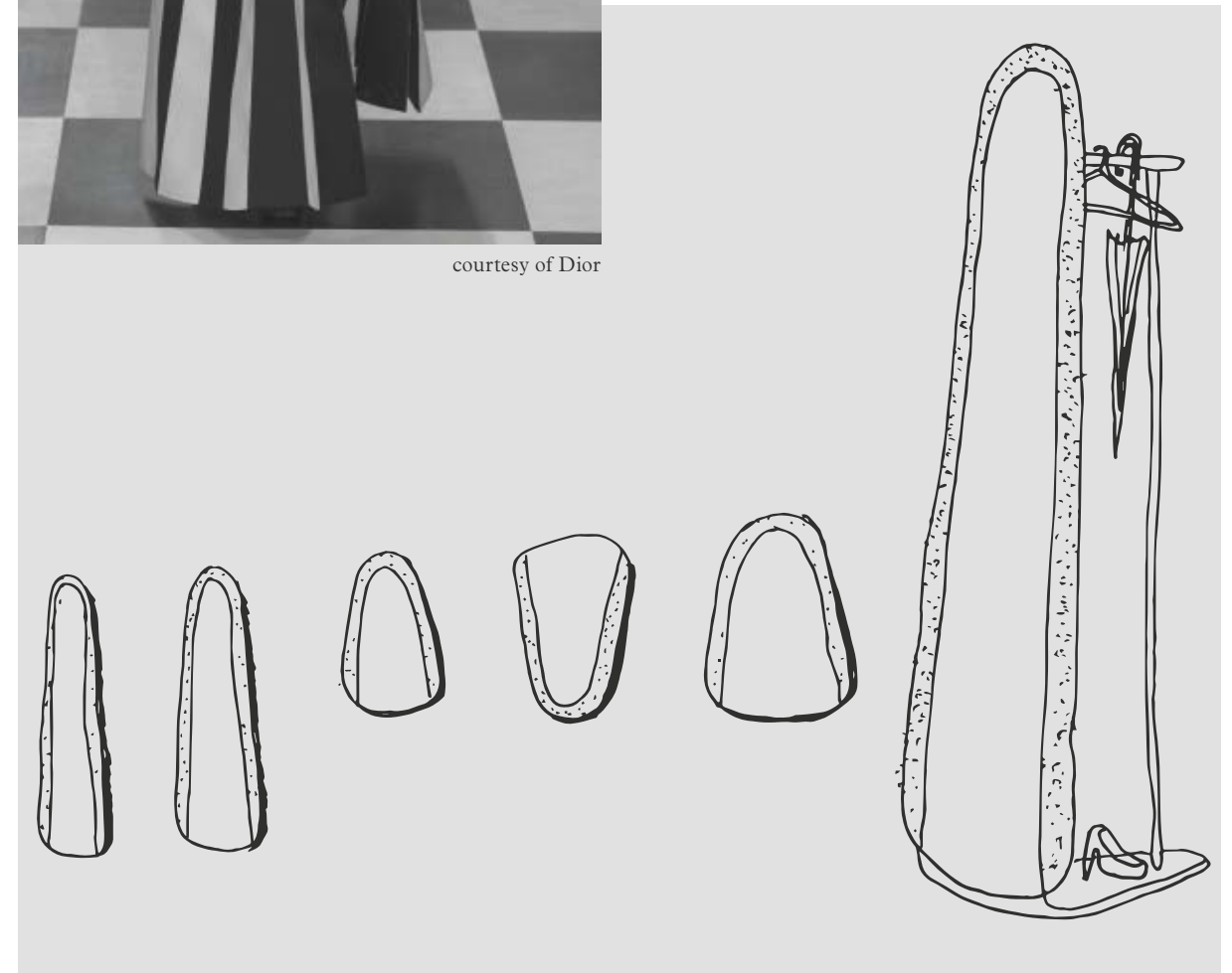

**SOVET**  
ITALIA

# A — Z index

## Collection

### Products

<b>228 - 231</b>	<b>3 Feet</b>	<b>110 - 119</b>	<b>Palace</b>
<b>146 - 151</b>	<b>Aikido</b>	<b>204 - 211</b>	<b>Piktor</b>
<b>276 - 279</b>	<b>Autumn chair</b>	<b>266 - 271</b>	<b>Pura</b>
<b>362 - 365</b>	<b>Boston</b>	<b>188 - 199</b>	<b>Quadro</b>
<b>168 - 179</b>	<b>Bridge</b>	<b>48 - 65</b>	<b>Regolo</b>
<b>288 - 293</b>	<b>Bugatti</b>	<b>212 - 215</b>	<b>Ring</b>
<b>258 - 265</b>	<b>Cadira</b>	<b>220 - 223</b>	<b>Rubino</b>
<b>298 - 303</b>	<b>Campos</b>	<b>330 - 335</b>	<b>Sail</b>
<b>336 - 345</b>	<b>Clessidra</b>	<b>404 - 405</b>	<b>Sakti</b>
<b>400 - 403</b>	<b>Clip</b>	<b>370 - 373</b>	<b>Segment</b>
<b>304 - 307</b>	<b>Combi</b>	<b>232 - 235</b>	<b>Shell</b>
<b>120 - 125</b>	<b>Cross</b>	<b>272 - 275</b>	<b>Sila</b>
<b>392 - 395</b>	<b>Delphi</b>	<b>396 - 399</b>	<b>Skyline</b>
<b>350 - 357</b>	<b>Denver</b>	<b>66 - 101</b>	<b>Slim</b>
<b>358 - 361</b>	<b>Denver Up</b>	<b>224 - 227</b>	<b>Spider</b>
<b>38 - 47</b>	<b>Deod</b>	<b>236 - 239</b>	<b>Swan</b>
<b>152 - 157</b>	<b>Flûte</b>	<b>216 - 219</b>	<b>Taky</b>
<b>284 - 287</b>	<b>Flûte girevole</b>	<b>158 - 161</b>	<b>Toronto</b>
<b>162 - 167</b>	<b>Frog</b>	<b>136 - 145</b>	<b>Totem</b>
<b>244 - 249</b>	<b>Genius</b>	<b>412 - 419</b>	<b>Traled lamp</b>
<b>374 - 377</b>	<b>Gocce di Rugiada</b>	<b>240 - 243</b>	<b>Tulip</b>
<b>382 - 385</b>	<b>Helia</b>	<b>280 - 283</b>	<b>Two tone chair</b>
<b>346 - 349</b>	<b>Horizon</b>	<b>132 - 135</b>	<b>Valencia</b>
<b>102 - 109</b>	<b>Kodo</b>	<b>366 - 369</b>	<b>Vertigo</b>
<b>126 - 131</b>	<b>Lambda</b>	<b>308 - 329</b>	<b>Visual</b>
<b>14 - 33</b>	<b>Magda</b>	<b>406 - 407</b>	<b>Wdrobe</b>
<b>386 - 391</b>	<b>Nest</b>	<b>250 - 253</b>	<b>Zeta</b>
<b>180 - 187</b>	<b>Nido</b>		

# product index

## tables



38 - 47  
Deod

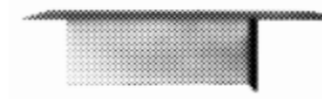

48 - 57  
Regolo



66 - 75  
Slim



76 - 77  
Slim extensible



102 - 109  
Kodo



110 - 115  
Palace



116 - 117  
Palace extensible



120 - 125  
Cross



126 - 131  
Lambda



132 - 135  
Valencia



136 - 141  
Totem



146 - 151  
Aikido



152 - 157  
Flûte



158 - 161  
Toronto



162 - 163  
Frog



168 - 170  
Bridge



# coffee tables



60 - 65  
Regolo



86 - 101  
Slim



142 - 144  
Totem



164 - 167  
Frog



244 - 249  
Genius



250 - 253  
Zeta



178 - 179  
Bridge



184 - 187  
Nido



188 - 195  
Quadro



204 - 211  
Piktor

# consoles



212 - 215  
Ring



216 - 219  
Taky



220 - 223  
Rubino



224 - 227  
Spider

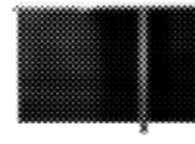

58 - 59  
Regolo



80 - 85  
Slim



171 - 177  
Bridge



180 - 183  
Nido



228 - 231  
3 Feet



232 - 235  
Shell

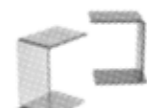

236 - 239  
Swan



240 - 243  
Tulip

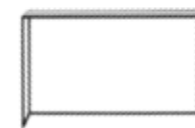

193 - 199  
Quadro

# seatings



258 - 261  
Cadira



262 - 265  
Cadira S



266 - 271  
Pura



272 - 273  
Sila 4 Legs



274  
Sila Cone Shaped



275  
Sila Trestle



276 - 279  
Autumn chair



280 - 281  
Two tone chair



282 - 283  
Two tone armchair



284 - 287  
Flûte girevole



288 - 293  
Bugatti



78-81  
Slim bench



97 - 101  
Slim sofa

# mirrors



298 - 303  
Campos

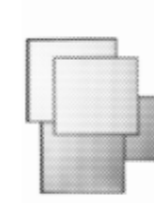

304 - 307  
Combi

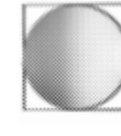

308 - 329  
Visual



330 - 335  
Sail



336 - 345  
Clessidra

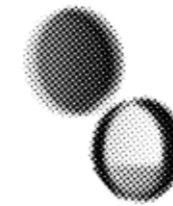

346 - 349  
Horizon

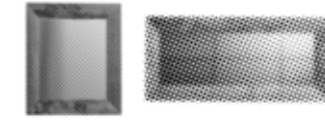

350 - 357  
Denver



358 - 361  
Denver Up

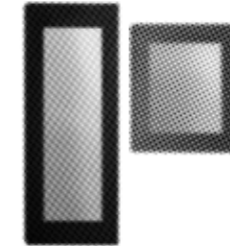

362 - 365  
Boston



366 - 369  
Vertigo

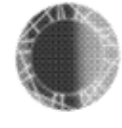

370 - 373  
Segment



374 - 377  
Gocce di Rugiada

# sideboards/accessories/lamps

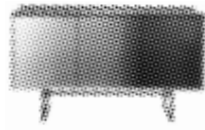

14 - 21  
Magda



22 - 33  
Magda suspended



30 - 33  
Magda shelves



382 - 385  
Helia

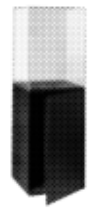

386 - 391  
Nest

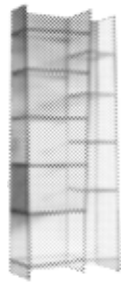

392 - 395  
Delphi



396 - 399  
Skyline



400 - 403  
Clip



404 - 405  
Sakti



406 - 407  
Wdrobe

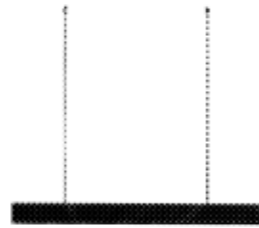

410 - 419  
Traled



## sideboards

A harmonious synthesis of form and function which is achieved through the combination of glass, ceramics and metal. Thus original and refined sideboards collections arise to characterize every space in a unique way, becoming an integral part of the new culture of living interiors.

Una sintesi armoniosa tra forma e funzione, ottenuta attraverso la combinazione di vetro, ceramiche e metallo. Nascono così delle collezioni di materie originali e raffinate al tempo stesso, destinate a caratterizzare in modo unico ogni tipo di spazio, diventando parte integrante di una nuova cultura dell'abitare gli interni.

# Magda

“

**Magda is a new collection of sideboards that combines the material aspect and the soft grains of the marble effect ceramic with the precious and fascinating shades of the Sovet's mirrors.**

Magda è una nuova collezione di madie che unisce la matericità e le morbide venature della ceramica effetto marmo alle preziose e affascinanti tonalità di specchio Sovet.

”

Design **Gianluigi Landoni**





**/ Magda is a sideboard characterized by the refined details: from the brass profile to the smoked glass shelves. Doors, structure and base can be customized to create a unique accessory.**

/ Magda è una madia che si contraddistingue per i raffinati dettagli: dal profilo in ottone ai ripiani in vetro fumé, è studiata per essere personalizzata nelle ante, nella struttura e nella base, creando un complemento unico.

**/ A precious detail of Magda with the structure in black Marquinia ceramic and brass profile.**

/ Un prezioso dettaglio di Magda con la struttura in ceramica nero Marquinia e il profilo in ottone.





**/ The elegant combination of a Gold Onyx structure and bronzed mirror doors.**

**/ Il raffinato connubio tra la struttura in Onice oro e le ante in specchio bronzo.**



**/ Two complementary of Magda versions: minimal with the Ceppo di Grè ceramic and the frosted smoked mirror doors, more luxurious in the gold mirror version of the other page.**

**/ Due versioni complementari di Magda: minimale in Ceppo di Grè ed ante specchio fumé acidato. Più ricca e lussuosa nella versione in tutto specchio oro nella pagina a lato.**





**/ The aesthetic richness of Magda is expressed through the refined marble-effect ceramics.**

**/ La ricchezza estetica di Magda è racchiusa nelle ricercate ceramiche effetto marmo.**



**/ Suspended Magda with push and pull opening-drawer.**

*/ Magda sospesa nella versione con cassetto ad apertura push and pull.*



**/ Version with drop down opening-door.**

*/ Versione con apertura ad anta e ribalta.*







**/ The Eramosa ceramic veins covers Magda's structure.**

/ Le venature della ceramica Eramosa vestono la struttura di Magda.





**/ Magda is a complete system for the living room. Not only sideboards but also shelves of various dimensions. In the picture shelves and structure in Eramosa ceramic. Front doors in extraclear mirror.**

**/ Magda è un vero e proprio sistema per la zona living. Non solo madie ma anche mensole di diverse dimensioni. Nella foto mensole e struttura madia in ceramica Eramosa. Ante frontali in specchio extrachiaro.**







## tables / consoles / coffee tables

Minimalism, functionality and uniqueness are the distinguishing features of Sovet's table collections. The bases in aluminum, metal, glass or wood, combined with the different material solutions available for the tops offer infinite furnishing possibilities for domestic or hospitality spaces. The consoles are a natural extension of the tables and can be combined also with coffee tables to create an harmonious atmosphere in the whole space.

Minimalismo, funzionalità e unicità estetica sono i tratti distintivi delle collezioni di tavoli Sovet. Le basi in alluminio, metallo, vetro o legno unite a molteplici soluzioni materiche per i piani offrono infinite possibilità d'arredo per destinazioni d'uso residenziale o ospitalità. Le console sono naturale estensione dei tavoli e possono essere abbinare anche a tavolini per creare un mood armonico in tutto lo spazio.



# Deod

“

A new table whose shapes and materials are enhanced in a natural equilibrium of geometries thanks to the iconic base inspired by the sculpted lines of the Dolomites.

Un nuovo tavolo dove forme e materiali vengono esaltati in un naturale equilibrio di geometrie grazie all'iconica base ispirata alle caratteristiche linee scolpite delle Dolomiti.

”

Design Gianluigi Landoni



**/ Deod with the sculptured burnished base and the precious top in gold onyx ceramic.**

/ Deod con la scultorea base brunita ed il piano imprezioso nella finitura ceramica onice oro.





**/ The Liquid glass top is a unique surface that creates original visual effects. It harmoniously matches the black embossed metal base and the Cadira chairs upholstered in black leather, to create sophisticated interiors.**

/ Il piano in Liquid glass è una superficie unica che crea effetti visivi inediti. Si abbina con armonia alla base in metallo gofrato nero e con le sedute Cadira rivestite in pelle nera, per interni dal sapore sofisticato.

**/ The harmonious contrast between the shapes of the embossed black base and the purity of the cement frosted glass top.**

**/ L'armonioso contrasto tra le forme della base goffrata nera e la purezza del vetro acidato color cemento.**





# Regolo

“

Different geometric shapes and various combinations of materials, create infinite uses and setting possibilities. A simple concept from which arises a complete collection of tables and accessories for the most varied environments and situations.

Forme geometriche e abbinamenti materici sempre diversi, creano infinite possibilità di ambientazione e utilizzo. Un concetto semplice dal quale nasce una famiglia completa di tavoli e complementi, per gli ambienti e le situazioni più diverse.

”

Design Lievore Altherr Molina





**/ A new perspective on the Regolo table that enhances its essential geometries.**

**/ Un'inedita prospettiva sul tavolo Regolo che ne esalta le geometrie essenziali.**











**/ Regolo in the square version with grey lacquered oak element and elegant smoked glass top.**



**/ Regolo nella versione square con traverso in legno rovere grigio e elegante piano in vetro fumé.**

**/ Regolo console with natural oak element matched with the Sail mirror and the Sila chair: ideal both for the home spaces and for the hospitality sector.**

**/ Regolo console con traverso in legno rovere naturale abbinata allo specchio Sail e alla seduta Sila: ideale sia per il settore domestico sia per l'hospitality.**





**/ A detail where the purity of the smoked glass, the black lacquered glass and the natural oak wood harmoniously blend.**

**/ Un dettaglio dove la purezza del vetro fumé, del vetro laccato nero e l'essenza del legno rovere naturale si fondono con equilibrio.**





**/ Plays of heights and materials create original combinations. Regolo coffee tables with top or base element in natural oak wood.**

**/ Giochi di altezze e materiali creano accostamenti sempre nuovi. Tavolini Regolo con piano o elemento base in legno rovere naturale.**





**/ The grey oak wood grains are supported by the sophisticated smoked glass. A process of shapes simplification to reach the essentiality.**

**/ Le venature del legno rovere grigio sono sostenute dalla raffinatezza del vetro fumé. Un processo di riduzione delle forme per arrivare all'essenzialità.**



# Slim

“

The Slim line is characterized by an essential design that conveys great lightness. Tables, coffee tables, consoles, benches and sofas that meet all tastes and requirements, fitting all kinds of situations.

La serie Slim è caratterizzata da un design essenziale che esprime grande leggerezza. Tavoli, tavolini, console, panche e divani che soddisfano ogni desiderio ed esigenza, in molteplici situazioni e abbinamenti.

”







**/ The minimal lines of Slim table with burnished base and oak stained wengè top blend with elegance.**

**/ Le linee minimali del tavolo Slim con base brunita e piano rovere tinto wengè si combinano con eleganza.**



**/ The Slim table with mocha embossed structure and mocha lacquered glass top.**

**/ Il tavolo Slim con struttura gofrata caffè e piano in vetro laccato caffè.**





**/ A perfect duo  
of minimalism and  
functionality: Slim  
square with titanium  
ceramic top.**

**/ Binomio di  
minimalismo e  
funzionalità: Slim  
square con piano in  
ceramica titanio.**





**/ The furnishing solutions of the Slim collection are multiple. Table with Canaletto Walnut top and Slim bench with Kvadrat's Hallingdal upholstery.**

**/ Le soluzioni d'arredo della collezione Slim sono molteplici. Tavolo con piano in noce Canaletto e panca Slim rivestita in tessuto Hallingdal di Kvadrat.**









/ **Slim console with mocha lacquered glass top and mocha structure.**

/ Slim console nella finitura vetro caffè e struttura caffè.





**/ Slim is enriched in elegance with the new Net glass finish.**

**/ Slim si arricchisce di eleganza con la nuova finitura Net glass.**



**/ Materic inspirations  
of the different  
combinations of  
materials for Slim  
collection.**

/ Ispirazioni  
materiche delle  
diverse combinazioni  
di materiali per  
la collezione Slim.





**/ The three different heights of the Slim coffee table allow to create multiple material combinations.**  
**Tops in bronzed Materia and Eramosa ceramic.**

**/ Le tre differenti altezze del tavolino Slim consentono di creare molteplici combinazioni e accostamenti materici. Piani in Materia bronzo e ceramica Eramosa.**





**/ Slim sofa: the new modular sofa in anthracite velvet with mocha structure creates a common thread with the coffee table in Gaudi Stone for the living rooms and lounge spaces.**

**/ Slim sofa: il nuovo divano modulare in velluto antracite con struttura caffè crea un fil rouge con il tavolino in Gaudi Stone nell'arredo della zona living e degli spazi lounge.**



**/ The armchair version of the Slim collection fits the different interior styles thanks to its minimal lines and the wide upholstery range.**

**/ La versione poltroncina della collezione Slim si integra con i diversi stili d'interni grazie alle linee minimali e all'ampia gamma di rivestimenti.**





**/ The Slim sofa upholstered in light blue velvet with low armrests and side end. The versatility offered by this collection is great thanks to the seating modules, with or without backrest, low or high armrests and optional side table.**

/ Slim sofa rivestito in velluto azzurro con braccioli bassi e terminale laterale. La versatilità offerta da questa collezione è massima grazie ai moduli seduta, con o senza schienale, bracciolo alto, basso e tavolino d'appoggio.





# Kodo

“

Available in more than 200 combinations,  
Kodo has been designed to reach  
large dimensions while maintaining an  
exceptional structural lightness.

Disponibile in più di duecento combinazioni  
è un tavolo disegnato per raggiungere  
imponenti dimensioni pur conservando una  
straordinaria leggerezza strutturale.

”



**/ The Ceppo di Gré ceramic, symbol of the Milanese 20th century architecture becomes a precious surface for the new Kodo table. In the picture is matched with the lively Sila cone shaped chair in red Kvadrat fabric.**

**/ La ceramica Ceppo di Gré, simbolo dell'architettura del Novecento milanese, diventa una pregiata superficie per il nuovo tavolo Kodo. Nella foto è accompagnato dalla vivace seduta Sila cone shaped in tessuto Kvadrat rosso.**







**/ The Kodo table with top in Gaudi Stone ceramic and Cadira armchair with wire shaped base.**

**/ Il tavolo Kodo con la superficie in ceramica Gaudi Stone e la poltroncina Cadira wire.**

**/ A version of Kodo enriched with a burnished finish for the base and a metallized champagne glass top. The Pura chair upholstered in white Kvadrat fabric thanks to its light and minimal shape fits the environment matching with different furniture styles.**

**/ Kodo in una versione impreziosita dalla finitura brunita per la base e dal vetro metallizzato champagne per il piano. La sedia Pura rivestita in tessuto Kvadrat bianco, dalla forma leggera e minimale, completa l'ambientazione e si adatta a diversi stili d'arredo.**



# Palace

“

Palace dining table and its unique design become the outright protagonist of the living area, thanks also to the new shapes. An important element that sets the mood of the whole room.

Il tavolo Palace, grazie al suo design inconfondibile e alle nuove forme, diventa il protagonista assoluto dello spazio giorno: un elemento importante che caratterizza l'intero ambiente.

”

Design Lievore Altherr Molina







**/ The new Palace shaped tables with marble-effect ceramics in the Gaudi Stone and Portoro finishes on the other page: both with burnished metal base to offer new furnishing inspirations.**

**/ I nuovi tavoli Palace shaped con i piani in ceramica effetto marmo nelle finiture Gaudi Stone e Portoro, nella pagina a lato, entrambi con base brunita, offrono nuove ispirazioni per l'arredo.**



/ Il tavolo Palace  
nella versione  
estensibile.

/ The Palace table  
in the extensible  
version.







# Cross

“

Two industrial-inspired elements that merge in a composition that reminds a railway crossing. This is the basic design idea of Cross, a table that represents a meeting point between the concepts of stability and dynamism, strength and harmony, thought and material.

Due elementi di ispirazione industriale che si compenetrano in una composizione che ricorda un incrocio ferroviario. Questa è la base progettuale di Cross, un tavolo che rappresenta un punto d'incontro fra i concetti di stabilità e dinamismo, forza e armonia, pensiero e materia.

”

Design Gianluigi Landoni



**/ The slender lines of  
the Cross iconic base  
in the embossed black  
and burnished finishes.**

**/ Le linee slanciate  
dell'iconica base Cross  
nella finitura gofrata  
nera e brunita a lato.**





# Lambda

“

The table has been inspired by the dynamism of a moving element, like the ribbon of a gymnast that vaults in the air drawing natural and soft shapes. Its original look furnishes the living area with a touch of essential harmony.

Lambda è ispirato al dinamismo di una forma in movimento, come il nastro di una ginnasta che volteggia nello spazio disegnando forme morbide e libere. La sua estetica originale si propone di arredare lo spazio giorno con una nota di essenziale armonia.

”

Design Gianluigi Landoni



**/ The sinuous  
and elegant lines  
of the Lambda base  
in burnished finish  
are enriched by the  
fine smoked glass top.**

**/Le linee sinuose  
ed eleganti della base  
Lambda in finitura  
brunita si arricchiscono  
con il piano in vetro  
fumé.**





**/ The pureness of the Cristalplant, above, and of the Canaletto walnut, below, enhances the Lambda iconic base.**

**/ La purezza del Cristalplant, sopra, e del noce Canaletto, sotto, esaltano l'iconica base del tavolo Lambda.**



# Valencia

“

Thanks to its transparent and aerial architecture the Valencia dining table creates original visual effects through the combination of the glass base and the top available in different materials and finishes. An idea that shapes infinite possibilities, always with a unique design.

Come un'architettura trasparente ed aerea, il tavolo Valencia crea inediti effetti visivi, attraverso l'abbinamento fra la base in cristallo e il piano in diversi materiali e finiture. Un'idea che dà forma a molteplici possibilità, sempre con un design inconfondibile.

”

Design Lievore Altherr Molina







# Totem

“

A lacquered metal base meets a top in glass, wood, ceramic or *Materia*, to give life to a tables collection with a distinctive personality and versatility in the setting, from home to contract spaces.

Una base in metallo laccato incontra un piano in cristallo, legno, ceramica o *Materia*, per dare forma a una famiglia di tavoli e tavolini tanto ricchi di personalità, quanto versatili nell'ambientazione: dagli ambienti domestici, agli spazi contract.

”





**/ The lacquered champagne Net glass characterizes the Totem top in harmony with the black leather seat of the Autumn chair.**

**/ Il Net glass laccato champagne caratterizza il piano di Totem in armoniosa sintonia con la seduta Autumn in pelle nera.**



**/ The Totem table with grey oak top and mocha base is combined with the minimal lines of Pura chair upholstered in dark grey Kvadrat fabric.**

**/ Il tavolo Totem con piano in rovere grigio e base caffè è accompagnato dalle linee minimali della sedia Pura rivestita in tessuto Kvadrat grigio scuro.**



**/ The Totem coffee tables make the living space warmer thanks to the wengé or natural oak wood tops.**

**/ I tavolini Totem riscaldano l'ambiente living con i piani in legno rovere naturale o tinto wengé.**





*/ The Totem coffee tables are studied to be combined with each other, in a height and material game. In the picture the bases are in embossed clay, while the tops are in white-lacquered glass and pearly Materia.*

*/ I tavolini Totem sono studiati per essere combinati tra di loro, in un gioco di altezze e materiali. Nella foto le basi sono in creta gofrato mentre i piani sono in vetro laccato bianco e Materia perlato.*



# Aikido

“

Aikido is a dining table of essential design which becomes protagonist of daily life and of any space thanks to its warm and prestigious materials. The single base matches with the round, oval or square top while the double base completed by the rectangular or shaped top is the ideal solution for big home spaces and meeting rooms.

L'essenziale design del tavolo Aikido lo rende protagonista dello spazio e della vita quotidiana grazie al calore e al prestigio dei materiali che lo compongono. La base è singola quando associata al top tondo, ovale o quadrato, oppure doppia per il piano rettangolare o shaped, adatto soprattutto a grandi ambienti casa e ufficio.

”



**/ The Aikido table with burnished metal base and extraclear transparent glass top, a unique choice for the living room interior.**

**/ Il tavolo Aikido con base in metallo brunito e top in vetro extrachiaro trasparente, un tavolo unico per gli interni living.**







# Flûte

“

Elegant and light like the namesake glass, this table expresses different personalities according to the chosen materials and colour combinations: from the top in lacquered glass, Materia, wood, ceramic or hpl, to the base in lacquered or polished chrome metal.

Elegante e leggero come il calice da cui prende il nome, questo tavolo assume diverse personalità a seconda degli abbinamenti materici e cromatici prescelti: dal piano in vetro laccato, Materia, legno, ceramica o hpl, alla base in metallo cromato o laccato.

”







**/ The Flûte table with cement frosted glass top and clay base is matched with the Sila chairs with natural oak seat: a solution that completes the kitchen and the living room spaces with a contemporary and minimal style.**

**/ Il tavolo Flûte con piano in vetro acidato cemento e base creta è abbinato alle sedie Sila con seduta in rovere naturale: una soluzione che completa la zona cucina e lo spazio living con uno stile contemporaneo e minimalista.**



# Toronto

“

The ceramic or lacquered glass top of Toronto table is supported by a wooden base. The legs with the special “V” profile give a lively visual sense of lightness, while maintaining the solidity and strong presence of the overall structure.

La lastra di cristallo laccato o ceramica che costituisce il top del tavolo Toronto è sorretta da una basamento in legno. Le gambe dal particolare profilo a “V” offrono alla vista una dinamica sensazione di leggerezza, mantenendo la solidità e la forte presenza dell'insieme.

”

Design Mara Panizzo



**/ The Toronto table with black lacquered glass top and the Autumn chair with ash structure and Canaletto Walnut seat that matches the table base.**

/ Toronto con piano in vetro laccato nero accompagnato dalla sedia Autumn con struttura in frassino e seduta in Noce Canaletto che si abbina alla base del tavolo.



# Frog

“

Frog tables are made from a single glass sheet curved and shaped with skillful technique. The purity of its design belies its exceptional strength for each setting and use, thanks to the use of a very thick bent glass.

I tavoli Frog sono realizzati con un'unica lastra di vetro, sagomata e piegata con sapiente tecnica. Alla purezza del design corrisponde una particolare resistenza, per ogni situazione ambientale e d'uso, grazie all'utilizzo di un grosso spessore di vetro curvato.

”





**/ The charm of the smoked glass is enhanced by the sinuous shapes of the Frog coffee table.**

**/ Il fascino del vetro fumé viene esaltato dalle forme sinuose del tavolino Frog.**





**/ Frog expresses all the Sovet's know-how in the glass bending. Refined detail of the extraclear glass.**

/ Frog esprime tutto il know-how di Sovet nella curvatura del vetro. Raffinato dettaglio del vetro extrachiaro.



# Bridge

“  
Bridge is a line of tables, coffee tables, consoles and desks that introduces the charm of glass into different environments: living room, bedroom, domestic office and contract. Available in different finishes, from the extralight to the smoked or lacquered glass.

Bridge è una famiglia di tavoli, tavolini, console e scrivanie che introducono il fascino del vetro nelle situazioni più diverse: dal living, allo spazio notte, allo studio domestico, al contract. Molteplici anche le finiture disponibili, dal vetro extrachiaro, al fumè, al laccato.

”









**/ The Hall console with the outside part lacquered in cement and the inside part in mocha is, at the same time, a functional writing desk or an elegant console.**

**/ La console Hall con vetro esterno laccato color cemento ed interno caffè è un funzionale scrittoio e un'elegante console allo stesso tempo.**







**/ A shape for infinite solutions: from the coffee table for the living area to the versatility of Trix set**

*/ Una forma per infinite soluzioni: dal tavolino per l'area living alla versatilità del set Trix*



# Nido

“

**Curved glass and metal profile are joined together to create a single form, able to create different chromatic combinations and types of furniture: from the coffee table to the console. An idea that can satisfy different needs with a unique style.**

Il vetro curvato e il profilo metallico si uniscono in una sola forma, proponendo diversi abbinamenti cromatici e tipologie d'arredo: dal tavolino, alla console. Un'idea che può risolvere con stile molte esigenze.

”







**/ The bent glass top meets and completes the minimalism of the metal structure; both elements are enhanced by the mocha lacquering.**

**/ Il top in vetro curvato incontra e completa il minimalismo della struttura in metallo; entrambi gli elementi sono esaltati dalla laccatura in caffè.**





**/ An elegant composition of Nido coffee tables in smoked glass with burnished base.**

**/ Un'elegante composizione di tavolini Nido in vetro fumé con base brunita.**





*/ The Nido coffee tables with top in mocha or rust lacquered glass and embossed mocha metal structure allow to enlarge or reduce the leaning surface thanks to the overlap of two elements in different heights.*

*/ I tavolini Nido con piano in vetro laccato caffè o ruggine e struttura in metallo gofrato caffè permettono di ampliare o diminuire la superficie d'appoggio grazie alla sovrapposizione di due elementi di diverse altezze.*



# Quadro

“

**A complete collection of coffee tables and consoles that allows to create original compositions in the living area. The ceramic tops, offered in a wide range including marble-effect ceramics, mirror, frosted mirror or Materia, are perfectly and naturally completed by the minimalism of the metal structure.**

Una collezione completa di tavolini e console che permette di creare originali composizioni nella zona living. I piani in ceramica, proposti nell'ampia gamma di finiture ceramica effetto marmo, specchio, specchio acidato o Materia, si fondono perfettamente e naturalmente con il minimalismo della struttura in metallo.

”

Design Lievore Altherr Molina





**/ Inspirational details  
of the Quadro base in  
burnished metal and  
embossed mocha.**

**/ Dettagli di ispirazione  
della base Quadro  
in metallo brunito e  
goffrato caffè.**





**/ Quadro coffee table with burnished base and Arabescato light ceramic top. Quadro console with pearly Materia top and burnished structure.**

**/ Quadro tavolino con base brunita e top in ceramica Arabescato light e console Quadro con piano in materia perlato e struttura brunita.**

**/ The combination of more elements creates different compositions. In the picture Quadro with mocha structure and Portoro and Gaudi stone ceramic top.**

**/ L'accostamento di più elementi crea molteplici composizioni. Nella foto Quadro con struttura caffè e piano in ceramica Portoro e Gaudi Stone.**



**/ Coffee tables with burnished and mocha bases, tops in smoked frosted mirror and marble effect ceramic Gaudi Stone, Stone Grey and Portoro.**

**/ Tavolini con basi brunito e caffè, piani in ceramica effetto marmo Gaudi Stone, Stone Grey, Portoro e specchio fumé acidato.**







**/ The Quadro console with Grey Onyx top combined with the elegance of the Skyline vase.**

**/ La console Quadro con il piano in onice grigio abbinato all'eleganza del vaso Skyline.**



“

**Not seeking for new  
extreme design trends  
but thinking about a  
new collection of tables,  
coffee tables and console  
of extreme quality and  
precision**

”



## coffee tables

Modular and original, Sovet's coffee tables for the living or the lounge areas stand out for their minimalism that perfectly blends with the sofa and the armchairs with aesthetic lightness and functionality. With metal bases and glass, ceramic or wooden tops, they are enriched by project details and shapes bringing out their essentiality.

Modulari e originali, per la zona living o le aree lounge, i tavolini Sovet si contraddistinguono per il loro minimalismo che accompagna sofà e poltrone con leggerezza estetica e funzionalità. Con basi in metallo e piani in vetro, ceramica o legno, sono impreziositi da dettagli progettuali e da forme che ne esaltano l'essentialità.

# Piktor

“

**The iconic Piktor coffee table, expressing with its shape Sovet's philosophy and skilled handcrafted processes, is now proposed in new glass and ceramic finishes that highlight its essential lines in the living spaces.**

L'iconico tavolino Piktor, esprimendo con la sua forma la filosofia e i processi artigianali di Sovet, viene proposto in nuove finiture di vetro e ceramica che esaltano le sue linee essenziali negli spazi abitativi.

”





**/ Piktor with  
burnished metal  
base and white  
lacquered glass top.**

**/ Piktor con base  
in metallo brunito e  
top in vetro laccato  
color bianco.**







# Ring

“

**Escher's impossible figures inspire a coffee table that finds its uniqueness on the particular design of the base, available singularly or matched with a glass top.**

Le geometrie impossibili di M. C. Escher ispirano un tavolino che fonda la sua unicità sul particolare design della base, disponibile da sola oppure abbinata ad un piano in vetro.

”







**/ A jewel of elegance  
for the living spaces:  
Ring with or without  
glass top.**

**/ Un gioiello di  
eleganza per gli  
spazi living: Ring  
con e senza top  
in vetro.**



# Taky

“

**From the skillful glass bending process arises a coffee table that combines the charm of traditional craftsmanship with the elegance of contemporary design. Available in different finishes, it brings harmony in each environment and meets every need.**

Dalla sapiente curvatura del vetro, nasce un tavolino che unisce il fascino della tradizione artigianale con l'eleganza del design contemporaneo. Proposto in varie finiture, per sintonizzarsi con ogni ambiente e desiderio.

”





# Rubino

“

Rubino is a jewel of elegance and manufacturing technique: the glass sweeping curve which is its distinguishing design feature, is achieved through an exclusive process which gives a feeling of floating lightness.

Rubino è un gioiello di eleganza ma anche di tecnica: la curvatura estrema della lastra di vetro che caratterizza il suo design, è realizzata con un procedimento esclusivo che gli conferisce una sensazione di immateriale sospensione.

”





**/ Glass bending details  
on the Rubino coffee  
tables.**

**/ Dettagli di curvatura  
del vetro nei tavolini  
Rubino.**



# Spider

“

**Spider is a coffee table made up with a single sheet of glass, artfully cut and bent: a pleasingly original presence in the living area. Matching freely the shapes and finishes it is possible to create infinite compositions, able to convey different emotions.**

Spider è un tavolino composto da un'unica lastra di cristallo, sapientemente tagliata e curvata: una presenza gradevolmente originale nello spazio giorno. Abbinando liberamente forme e finiture, è possibile creare le più diverse composizioni, in grado di trasmettere emozioni differenti.

”

Design **Lievore Altherr Molina**





# 3 Feet

“

**3 Feet is a collection of hexagonal coffee tables made of bent glass, able to give to the house a lively touch of originality. They can be put together playing with the different heights and finishes.**

3 Feet è una collezione di tavolini esagonali, realizzati in vetro curvato, che donano alla casa un vivace tocco di originalità. Si possono accostare giocando con diverse altezze e finiture.

”







# Shell

“  
**Shell is a coffee table with  
harmonious lines. Bent through exclusive  
technologies, it allows to place and  
at the same time display any kind  
of object with a special style.**

Shell è un tavolino dalle linee armoniose.  
Curvato con tecnologie esclusive, Shell  
permette di appoggiare e allo stesso  
tempo esporre, gli oggetti più diversi  
con uno stile speciale.

”



**/ Shell highlights the  
lightness of the glass  
in the living area.**

**/ Shell esalta la  
leggerezza del vetro  
nello spazio giorno.**



# Swan

“

**Swan is a multifunctional piece of furniture: a single bent glass sheet that blends perfectly with other contemporary furnishing complements, also thanks to the possibility of choosing among several colour options.**

Swan è un originale mobile multifunzione: un'unica lastra di vetro curvato che si integra perfettamente con altri elementi d'arredo contemporaneo, anche grazie alla possibilità di scegliere fra diverse varianti cromatiche.

”





**/ Swan:**  
**a natural way**  
**to match seatings**  
**and sofas with**  
**functionality.**

**/ Swan:**  
**un modo naturale**  
**di accompagnare**  
**le sedute e i sofà**  
**con funzionalità.**



# Tulip

“

**Tulip is designed to offer a useful support top in lounge areas, adding value to the whole space with its refined design. The choice among different materials and colours available for the top allows different interpretations and leaves the imagination free in each furniture setting.**

Tulip è progettato per offrire una comoda superficie di appoggio nella zona relax, arricchendo lo spazio circostante con il suo raffinato design. La scelta fra diversi materiali e colori per il top, lascia libero spazio all'interpretazione ed all'immaginazione, in ogni contesto d'arredo.

”





**/ Material and height compositions for domestic and contract spaces: Tulip is an essential and at the same time versatile coffee table.**

**/ Composizioni materiche e di altezze per spazi home e contract: Tulip è un tavolino dal profilo essenziale e versatile allo stesso tempo.**



# Genius

“

**This original and versatile series of coffee tables is available in different shapes, sizes, materials for the top and in different finishes for the metal base. Ideal as lamp/ coffee table, it perfectly matches with any kind of seat, thanks to its lively personality.**

Questa originale e versatile serie di tavolini è proposta in diverse forme, misure, materiali per il top e in diverse finiture per la base metallica. Ideale come lamp/coffee table, affianca con personalità vivace ogni tipo di seduta.

”







**/ Genius coffee table with burnished metal base and tobacco lacquered glass top.**

**/ Genius con la base in metallo brunito e piano in vetro laccato color tabacco.**



**/ The Genius coffee tables allow to create original combinations: the ceramic, the Materia and the wood grains are combined with the burnished or embossed metal bases in a binomial of elegance and minimalism for home & contract interiors.**

**/ I tavolini Genius permettono di creare accostamenti sempre nuovi: la ceramica, il Materia e le venature del legno si combinano alle basi brunate o goffrate in un binomio di eleganza e minimalismo per interni home & contract.**



# Zeta

“

Pureness and minimalism are the keys to understanding a product which combines simplicity and functionality. Entirely realized in glass it can be a magazine holder and a practical coffee table.

Purezza e minimalismo sono le chiavi di lettura di un prodotto che unisce semplicità e funzionalità. Interamente realizzato in vetro questo funge al tempo stesso da portariviste e pratico tavolino.

”

Design Gianluigi Landoni





**/ Glass and design  
find their meeting  
point in the Zeta  
lines.**

**/ Vetro e design  
trovano il loro punto  
d'incontro nelle  
linee di Zeta.**



“

**Design without content is  
not design but merely a  
colored surface**

”



## seatings

The seating collections express the transversal nature of Sovet's know-how and production process. Comfortable, ergonomic and with charming lines, they are a synthesis of aesthetic research and functionality. The different bases offered match the table bases and the other furnishing elements. A wide and careful selection of fabrics, leathers, fake leathers and velvets, allows to best customize domestic and hospitality spaces, such as restaurants, meeting rooms, lounge areas and offices, always with the best quality standards.

Le collezioni di sedute esprimono la trasversalità del know-how e della produzione Sovet. Confortevoli, ergonomiche e dalle linee seducenti sono sintesi di ricerca estetica e funzionalità. I diversi basamenti proposti si integrano con le finiture delle basi dei tavoli e degli elementi d'arredo. Un'ampia e precisa selezione di tessuti, pelli, ecopelli e velluti permette la massima personalizzazione in ambienti home e contract, come sale ristoranti, sale riunioni, aree lounge e spazi office, sempre con i massimi standard qualitativi.

# Cadira / Cadira S

“

A seating with an enveloping and comfortable shape that matches with elegance and simplicity the tables of Sovet's collection. The Cadira chair finishes, from leather and fake leather to fabric and velvet, complete the different types of structure making it adapt for any kind of public or private space.

Una seduta dalla forma comoda ed avvolgente che accompagna con raffinatezza e semplicità i tavoli della collezione Sovet. Le finiture di Cadira, dalla pelle e ecopelle fino al tessuto e al velluto, si uniscono a diverse tipologie di struttura personalizzando la seduta per gli interni pubblici e privati.

”





**/ Cadira with armrests upholstered in black and red Kvadrat. The base is in embossed metal, Wire version.**

**/ Cadira con braccioli rivestita in tessuto Kvadrat nero e rosso. La base è in metallo goffrato nella versione Wire.**









**/ Cadira wire in the version without armrests upholstered in Hallingdal.**

**/ Cadira wire nella versione senza braccioli rivestita in tessuto Hallingdal.**

# Pura

“

Versatile and ergonomic in the shape and characterized by a refined simplicity, the Pura chair is available with different coverings, to play different roles in the home and contract space.

Versatile ed ergonomica nella forma, caratterizzata da una raffinata semplicità, Pura si presenta con diversi rivestimenti, per interpretare molteplici ruoli nell'ambiente domestico o contract.

”





**/ Pura series  
upholstered in three  
colour options of  
Hallingdal fabric.**

**/ Serie di Pura rivestita  
in tre colorazioni di  
tessuto Hallingdal.**



**/ Details of the ergonomics on the Pura's back, which promotes a natural position sitting.**

**/ Dettagli della ricerca ergonomica nello schienale di Pura che favorisce una seduta in posizione naturale.**



# Sila

“

**Sila is a chair project from which a lot of different versions take form, starting from simple shapes and natural materials. The body in multi-layer wood, available also padded and covered, is supported by a slim metal base, stackable or trestle.**

Sila è un progetto di seduta che dà vita a tante varianti diverse, partendo da forme semplici e materiali naturali. La scocca in legno multistrato, disponibile anche con imbottitura e rivestimento, è sostenuta da una snella base metallica, impilabile oppure a trespolo.

”



**/ The fine  
upholstering  
of the Sila chair  
in brown leather  
or black Kvadrat  
fabric provides  
a comfortable  
seat for home &  
contract interiors.**

**/ Il pregiato  
rivestimento di Sila  
in pelle marrone  
o tessuto  
nero Kvadrat  
offre una confortevole  
seduta per interni  
contract & home.**



# Autumn Chair

“

Characterized by a sophisticated balance between structure and seat, which appears to be suspended, it represents the typical expression of Italian craftsmanship. The structure is realized in curved wood, with a natural, black stained or walnut finish, combined with a wooden or covered seat in various finishes.

Sofisticata nel rapporto fra la struttura e il sedile, che risulta come sospeso, rappresenta una tipica espressione dell'artigianalità italiana. La struttura è infatti realizzata in legno curvato, con finitura naturale, nera o noce, ed è abbinata al sedile in legno o rivestito in varie finiture.

”







**/ Autumn with walnut finish structure and seat covered in mocha leather.**

**/ Autumn con struttura in finitura noce e sedile rivestito in pelle mocha.**



# Two Tone Chair

“

**Versatile, comfortable and friendly, this chair is realized with curved wood structure. It can be with or without armrests, and has a multi-layer body covered in leather, fake leather, fabric or velvet. The version without armrests is stackable up to 4 chairs.**

Versatile, accogliente ed amichevole, questa seduta è realizzata con una struttura in legno curvato, può essere con o senza braccioli e presenta una scocca in multistrato rivestita in pelle, ecopelle, tessuto o velluto. La versione senza braccioli è impilabile fino a 4 sedie.

”



**/ Detail of the curve  
of the wood on the  
Two tone's version  
with armrests in  
black-stained ash  
and leather covered  
seat.**

/ Dettaglio della  
curvatura del legno  
nella versione  
di Two tone con  
braccioli in frassino  
nero e seduta  
rivestita in pelle  
nera.



# Flûte Girevole

“

**Flûte is a swivel chair that is ideal for different places such as home and office. It is available with polished chrome or lacquered metal structure. The comfortable seat with arms is in white, black or mocha polypropylene. The fake leather cushion makes the seat more comfortable.**

Flûte girevole è una sedia che si adatta a molteplici ambienti, sia nella casa che nell'ufficio. È disponibile con struttura in metallo cromato o laccato. La comoda scocca con braccioli è realizzata in polipropilene bianco, nero oppure caffè. La seduta è resa ancora più comoda da un cuscino in ecopelle.

”





# Bugatti

“

**Bugatti has all the features to be a protagonist in home & contract spaces.**

**The thickness of the padded cushion creates an elegant contrast with the slim lines of the structure, which supports a comfortable seat upholstered in leather, eco-leather, fabric or velvet.**

Bugatti ha tutte le qualità per essere la protagonista degli spazi home & contract.

Lo spessore del cuscino imbottito crea un contrasto elegante con le linee sottili della struttura che sostiene una confortevole seduta rivestita in pelle, ecopelle, tessuto o velluto.

”

Design Lievore Altherr Molina



**/ The essential lines of the embossed clay structure of Bugatti match the seat and the cushion upholstered in grey Kvadrat fabric. An ideal solution for living and lounge areas.**

**/ La struttura dalle linee essenziali in metallo gofrato creta di Bugatti, accompagna la seduta ed il cuscino imbottiti in tessuto Kvadrat grigio. Una soluzione ideale per lounge area e zone giorno.**







“

**Design speaks a universal  
language and builds  
memorable forms with  
indelible meanings**

”



## mirrors

Not only seeking in the reflection the functionality, but also finding in it new solutions that give life to eclectic furnishing elements for any kind of domestic and hospitality space: this is what Sovet's mirrors collection expresses. The different mirror shades used, from extraclear to smoked, bronzed, rose and gold, create original atmospheres in different environments.

Non solo cercare nella riflessione la funzione, ma trovare in essa nuove soluzioni che diano vita ad oggetti d'arredo e decoro per tutti gli ambienti domestici e contract: questo è rappresentato dalla collezione di specchiere Sovet. Le diverse tonalità di specchio usate, da quello extrachiaro, al fumè, bronzo, rosa o oro creano inedite atmosfere negli ambienti.

# Campos

“

Campos is a new mirror concept. It combines a graphic composition with different mirror shades, giving life to a furnishing element that acquires full autonomy in the architectural spaces, offering new perspectives of reflection thanks to the sloping smaller mirror.

Campos è un nuovo concetto di specchiera. Combina una composizione grafica con diverse tonalità di specchio creando un elemento d'arredo che assume piena autonomia negli spazi architettonici, offrendo nuove prospettive di riflessione grazie allo specchio più piccolo inclinato.

”

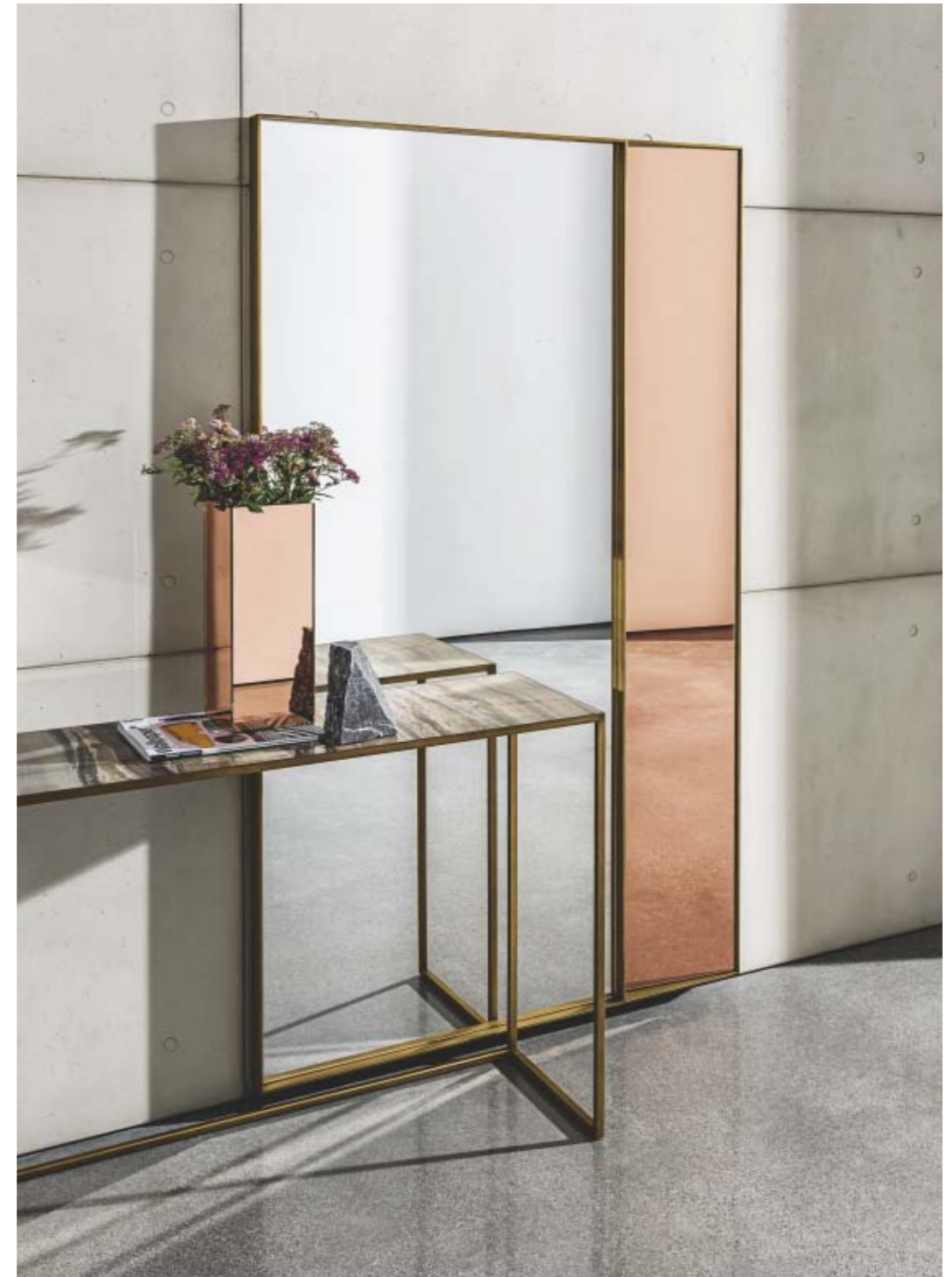

**/ The Campos mirror, with burnished structure and rose and extraclear mirrors, is combined with the Bugatti armchair with the same structure finish and Kvadrat's Hallingdal upholstery.**

**/ La specchiera Campos, con struttura brunita e specchi rosa ed extrachiaro, accompagna la seduta Bugatti con la stessa finitura di struttura e rivestimento in tessuto Hallingdal di Kvadrat.**





# Combi

“

Combi makes the spaces abstract like in a painting thanks to the various reflections and the different mirror shades. The aluminium structure separates but also accompanies harmoniously the different parts like in a mosaic. The reflection is the element that gives significance to the space.

Combi astrae gli spazi come in un dipinto grazie alle molteplici riflessioni ed alle diverse tonalità di specchio. La struttura in alluminio divide ma allo stesso tempo accompagna in modo armonioso le varie parti come in un mosaico, dove la riflessione è il tassello che dà significato allo spazio.

”

Design Gianluigi Landoni





**/ Combi can be oriented to the four directions, creating from time to time a different composition with a new aesthetic effect.**

**/ Combi può essere orientata in tutte e quattro le direzioni creando di volta in volta composizioni esteticamente diverse.**



# Visual

“  
The new shapes and sizes of the Visual mirrors create original reflections thanks to different shades and to their modularity. They furnish private and public spaces with a refined simplicity making possible the creation of large compositions.

Le nuove forme e dimensioni delle specchiere Visual creano inedite riflessioni grazie alle diverse tonalità di specchio e alla loro modularità. Arredano spazi abitativi privati o pubblici con raffinata semplicità lasciando spazio alla libera creazione di grandi composizioni.

”

Design Lievore Altherr Molina





**/ The free-standing Visual is a functional double-faced mirror that gives the possibility to choose two different shades for the front and for the back. In the picture: burnished structure and extraclear mirror in the foreground; mocha structure and smoked mirror for the Visual in the background.**

**/ Visual free standing è un funzionale specchio bifacciale con la possibilità di avere due tonalità diverse per il fronte e per il retro. Nella foto: struttura brunita e specchio extrachiaro in primo piano; struttura caffè e specchio fumé per la Visual in secondo piano.**



**/ In this version, the Visual mirror is the sole protagonist of home & contract spaces thanks to its fascinating gold mirror and the precious burnished frame.**

/ In questa versione Visual diventa uno specchio protagonista degli spazi home & contract grazie al suo fascino e alla preziosa cornice brunita accompagnata dalla tonalità di specchio oro.



**/ Elegant reflections of two Visual mirrors with embossed mocha frame and extraclear mirror. The minimal structures create geometries that transform the mirror into a particularly eclectic furnishing element.**

/ Riflessioni eleganti di due specchiere Visual con cornice gofrata caffè e specchio extrachiaro. Le minimali strutture creano geometrie che trasformano lo specchio in un elemento d'arredo particolarmente eclettico.



**/ Visual geometric with  
mocha frame and rose  
mirror.**

**/ Visual geometric con  
cornice caffè e specchio  
rosa.**





**/ Visual round with  
burnished frame and rose  
mirror.**

**/ Visual round con  
cornice brunita e specchio  
rosa.**

**/ The minimalism of the  
burnished and mocha  
embossed frames of  
Visual surrounds  
the reflections of  
architectural spaces**

**/ Il minimalismo delle  
cornici Visual brunate e  
goffrate caffè circonda  
riflessioni di spazi  
architettonici.**







**/ The combination of different sizes of the Visual hexagonal mirrors and the different shades of extralight, rose, smoked and gold mirror, make possible the creation of large compositions.**

/ L'accostamento di diverse dimensioni di Visual esagonali e le diverse tonalità di specchio extrachiaro, rosa, fumè ed oro lasciano spazio alla libera creazione di grandi composizioni.







**/ The new decagonal shape of Visual creates magnificent reflections in the interiors.**

**/ La nuova forma decagonale di Visual crea riflessioni sublimi negli interni.**



# Sail

“

Concave and convex mirrors create amazing effects and compositions, projecting the space into a new dimension.

Specchi concavi e convessi creano sorprendenti effetti e composizioni, proiettando lo spazio in una nuova dimensione.

”

Design Lievore Altherr Molina



**/ An elegant reflections  
game created by  
the Sail mirrors.**

**/ Un elegante gioco di  
riflessioni creato dalle  
specchiere Sail.**





# Clessidra

“

The Clessidra mirror, with its soft lines and its sanded frame, can be positioned with different orientations. It assumes a new functional feature in the table and free-standing versions. Because it is not possible to stop time, but choosing how to look into the mirror while time passes by is.

La specchiera Clessidra con le sue forme morbide e la sua cornice sabbiata può essere posizionata con orientamenti diversi. Assume un nuovo carattere funzionale nelle versioni da tavolo e free standing. Perché non è possibile fermare il tempo, ma scegliere come guardarsi mentre trascorre sì.

”





**/ Clessidra in rose mirror embellishes the interiors with its simplicity and refinement.**

**/ Clessidra in specchio rosa impreziosisce gli interni con la sua semplicità e raffinatezza.**







**/ In the table version, Clessidra becomes a unique and timeless design object.**

**/ Nella versione da tavolo, Clessidra diventa un oggetto di design unico e senza tempo.**





**/ Not only a mirror,  
but a particularly  
eclectic complement:  
the free-standing  
Clessidra combines  
the reflection with the  
coat-hanger function.**

**/ Non solo una  
specchiera ma un  
complemento  
particolarmente  
eclettico: Clessidra  
da terra unisce alla  
riflessione la funzione  
di appendiabiti.**



# Horizon

“

Horizon mirror is bordered by an aluminium frame characterized by a thin moulding at the edge. The reflective surface is also available with a frosted finish that draws an horizon line, playing with light and proportions. The different available sizes and the wall swivel fixing allow to create different situations and compositions.

Lo specchio Horizon è incorniciato da un telaio in alluminio, caratterizzato da una sottile modanatura sul bordo. La superficie riflettente è disponibile con un'acidatura che disegna un orizzonte visivo, giocando con la luce e le proporzioni. Le diverse dimensioni disponibili e l'attacco a parete orientabile consentono di creare diverse situazioni e composizioni.

”





# Denver

“

The Denver mirrors collection embraces the new ceramic frames. The different mirror shades available for the central mirror, from the extralight to the bronzed and the smoked, allow to create unique combinations that furnish the interiors in harmony with different styles and environments.

La collezione di specchiere Denver si arricchisce con le nuove cornici in ceramica. Le diverse tonalità di specchio centrale proposte, dall'extrachiaro al bronzo fino al fumé permettono di creare combinazioni uniche che arredano gli interni in armonia con diversi stili e ambienti.

”





**/ A fine detail, where the bronzed and smoked frame are a natural extension of the central mirror.**

**/ Un raffinato dettaglio dove le cornici nelle tonalità bronzo e fumé diventano naturale estensione dello specchio centrale.**





**/ The versatility of Denver and the wide range of possible combinations create a perfect balance with the Magda sideboard, giving a "material aspect" to the environment. In the picture: Gold Onyx ceramic for the Denver frame and for the Magda structure. Mirror and doors in bronze finish.**

**/ La versatilità di Denver e l'ampia gamma di configurazioni creano una perfetta integrazione con Magda definendo un richiamo materico nell'ambiente. Nella foto: ceramica onice oro per la cornice Denver e per la struttura di Magda. Specchio e ante in finitura bronzo.**





# Denver Up

“

Denver Up adds to the wide mirrored surface that is raised from the frame, the magic of the light spreading out directly from its perimeter and creating a very particular effect: both in horizontal and vertical version.

Denver Up aggiunge all'ampia superficie riflettente dello specchio, sollevato rispetto alla cornice, la magia della luce che si diffonde direttamente dal suo perimetro, creando un effetto molto particolare: sia nella versione verticale che in quella orizzontale.

”





**/ Denver up with a frosted champagne glass frame. The mirror is raised from the frame to bring the light in the foreground.**

**/ Denver up con cornice in vetro acidato champagne. Lo specchio è rialzato rispetto alla cornice per portare la luce in primo piano.**



# Boston

“

**Boston is a wall mirror that reflects an in-depth search for simplicity and beauty. The lacquer finish of the frame, available in various colours, is applied to the back of the glass for an even shinier aspect. Available also in a totally mirrored finish.**

Boston è una specchiera da parete che riflette un'approfondita ricerca di semplicità e bellezza. La laccatura del bordo, in diversi colori, è applicata sul retro del cristallo: questo la rende ancora più brillante alla vista. Viene inoltre proposta anche in versione completamente a specchio.

”





# Vertigo

“

The special engraving that surrounds the mirrored surface of Vertigo creates a particular visual effect, able to give a touch of originality to the room. Available in various sizes, it can be also provided with a led lighting on the back that enhances its scenographic presence.

La particolare incisione che circonda la superficie riflettente dello specchio Vertigo, crea un particolare effetto visivo, destinato a non restare inosservato nello spazio. Disponibile in varie dimensioni, può essere dotato di sistema di retroilluminazione a led che ne accresce la presenza scenografica.

”

Design Gianluigi Landoni





# Segment

“

Segment is a wall mirror with engraved segments of great visual impact. Available in various sizes in the square, rectangular or round shape, also with a led lighting on the back that catches the eye to the segment decoration.

Segment è una specchiera da parete di forte impatto visivo, caratterizzata dal bordo con incisioni geometriche. È disponibile con forma quadrata, rettangolare o rotonda, in diverse dimensioni ed anche con retroilluminazione a led che ne mette in evidenza il decoro segmentato.

”

Design Gianluigi Landoni







# Gocce di Rugiada

“

Gocce di rugiada is a collection of soft lines mirrors, like lots of water drops gliding from autumn leaves. This feature, together with the panel on the back that allows a 360° rotation, allows to create infinite combinations, with even newer effects. Available also in the smoked and bronzed version to get further chromatic choices.

Gocce di Rugiada è una collezione di specchi dalle forme morbide, come gocce che scivolano su una foglia. Questa caratteristica, unita alla possibilità di ruotare gli specchi a 360°, permette di creare le più diverse combinazioni, con effetti sempre diversi. Disponibili anche in versione fumè e bronzo, per dare vita a ulteriori scelte cromatiche.

”

Design Gianluigi Landoni



**/ Composition of Gocce di Rugiada mirrors in various mirror shades.**

**/ Composizione di Gocce di Rugiada in varie tonalità di specchio.**



“

**Design is like a secret:  
whether small or large, it  
fascinates**

”



## accessories

In its vision of the interiors-living culture, Sovet offers a wide range of functional accessories that recall the lines and materials of the collections, completing them and providing an original and distinctive touch; cases, vases and bookshelves with a minimal but refined style.

Nella sua visione della cultura di abitare gli interni, Sovet propone un'ampia gamma di complementi funzionali che, riprendendo le linee e i materiali delle collezioni, le integrano, donando un tocco originale e distintivo; teche, vasi e librerie, dal sapore minimalista e ricercato.

# Helia

“

The refined and minimal structure of Helia is enhanced by the shelves in bronzed or smoked mirror to give an exclusive charm to the interiors. The two sizes and the different widths allow different uses and combinations.

La struttura ricercata e minimale di Helia è impreziosita dalle mensole in specchio bronzo o fumé per donare un fascino esclusivo agli interni. Le due dimensioni e le diverse profondità permettono vari utilizzi e accostamenti.

”

Design Gianluigi Landoni





**/ Helia with bronzed mirror and embossed mocha metal structure.**

**/ Helia con specchio bronzo e struttura in metallo gofrato caffè.**

# Nest

“

An elegant, essential and modular solution, to transform every space into a fascinating display.

Una soluzione elegante, essenziale e modulare, per trasformare qualsiasi spazio in un'affascinante esposizione.

”

Design Lievore Altherr Molina

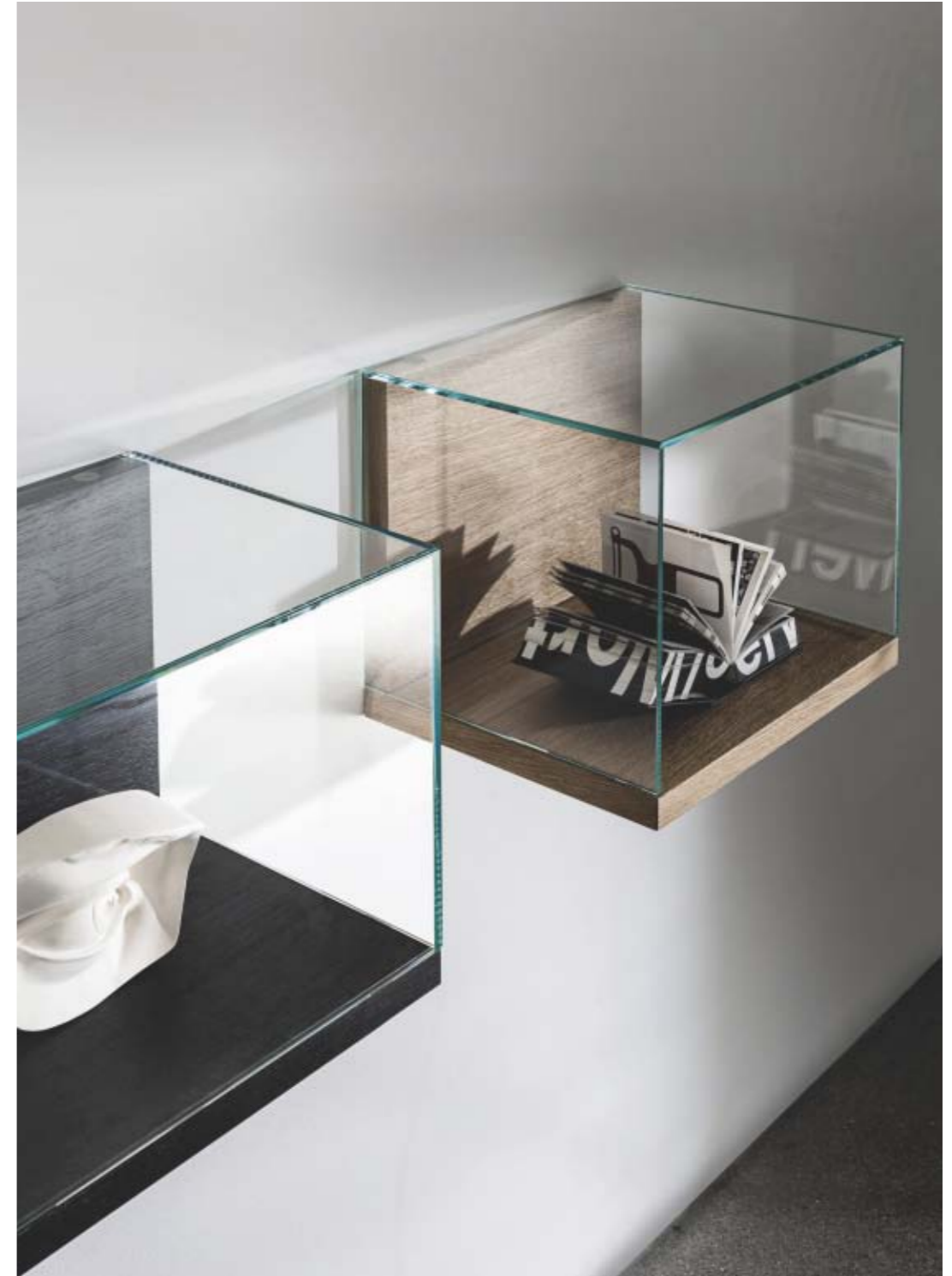



**/ The wall free standing or middle room versions of Nest are ideal for commercial and exhibition spaces. Both the versions are provided with a functional storage underneath.**

**/ Le versioni da parete o da centro stanza di Nest sono l'ideale per l'arredo di spazi commerciali ed espositivi. Entrambe le versioni sono dotate di un funzionale contenitore sottostante.**





# Delphi

“

Delphi is a glass modular bookcase that creates a sinuous “wave” effect through its trapezoidshaped shelves of different sizes. The smoked glass version has a refined charm while the extralight finish looks particularly light and spreads brightness in the room.

Delphi è una libreria modulare in vetro che, grazie a ripiani di forma trapezoidale di misure diverse, crea un sinuoso effetto “onda”. La versione in vetro fumè ha un fascino raffinato, mentre quella in extrachiaro è particolarmente leggera e diffonde luminosità nell’ambiente.

”





# Skyline

“

Cases entirely made of glass, in different finishes decorate the indoor spaces with versatility.

Contenitori completamente in vetro, con diverse finiture, arredano il paesaggio d'interni con versatilità.

”

Design Gianluigi Landoni





# Clip / Sakti / Wdrobe

“

A series of three coat-hangers of unique design that perfectly completes Sovet's new vision of living the interiors with minimalistic luxury and refined style.

Una serie di tre appendiabiti unici nel design che completano al meglio la nuova visione Sovet di abitare gli interni con lusso minimalista e stile ricercato.

”





/ Clip coat hanger consists of three metal elements of various heights, welded together to increase the capacity.

/ Clip coat hanger ha una forma costituita da tre elementi in metallo di varie altezze saldati fra loro per moltiplicare la sua capienza.





**/ Three elements with functional grooves are expertly joined together through rails that allow hangers hooking. Sakti coat hanger in walnut, natural and black finished ash.**

**/ Tre elementi con dei funzionali incavi sono sapientemente uniti attraverso dei raccordi che permettono l'aggancio di grucce. Sakti appendiabiti nelle finiture di frassino noce, naturale e nero.**







**/ Wdrobe in embossed metal with accessories in polished copper: icon of minimalism and functionality thanks to the practical coin tray.**

/ Wdrobe in metallo gofrato con accessori in rame lucido: icona di minimalismo e funzionalità grazie al pratico svuotatasche.



“

**Always active, constantly  
evolving, we are a  
community of designers  
who creates projects that  
add value to everyday life**

”



# lamps

Light as a natural element that fits different spaces, creating fascinating atmospheres. That's the concept from which Sovet's new lamps came to life. Drawing sensibility, minimal shapes and aesthetic research are combined with a careful lighting concept to irradiate the interiors with pleasant sensations.

La luce come elemento naturale che si integra negli ambienti creando atmosfere affascinanti. Nascono così le nuove lampade Sovet. Sensibilità nel disegno, forme minimali e ricerca estetica si combinano a precisi studi illuminotecnici per irradiare gli interni di piacevoli sensazioni.

# Traled

“

The new Traled lamps collection is the result of a shapes reduction to obtain a minimal but refined assembly. Two ceramic, mirror or frosted mirror sides, finished in the details, which create a luminous aura. The brass finishes embellish the collection creating a versatile light for elegant interiors and contract spaces.

La nuova collezione di lampade Traled è frutto di una riduzione delle forme per ottenere un assieme minimale e raffinato al tempo stesso. Due lati di ceramica, specchio o specchio acidato, rifiniti in tutti i dettagli, dai quali esce un fascio luminoso. Le finiture in ottone impreziosiscono la collezione creando una luce versatile per interni raffinati e spazi contract.

”

Design Gianluigi Landoni



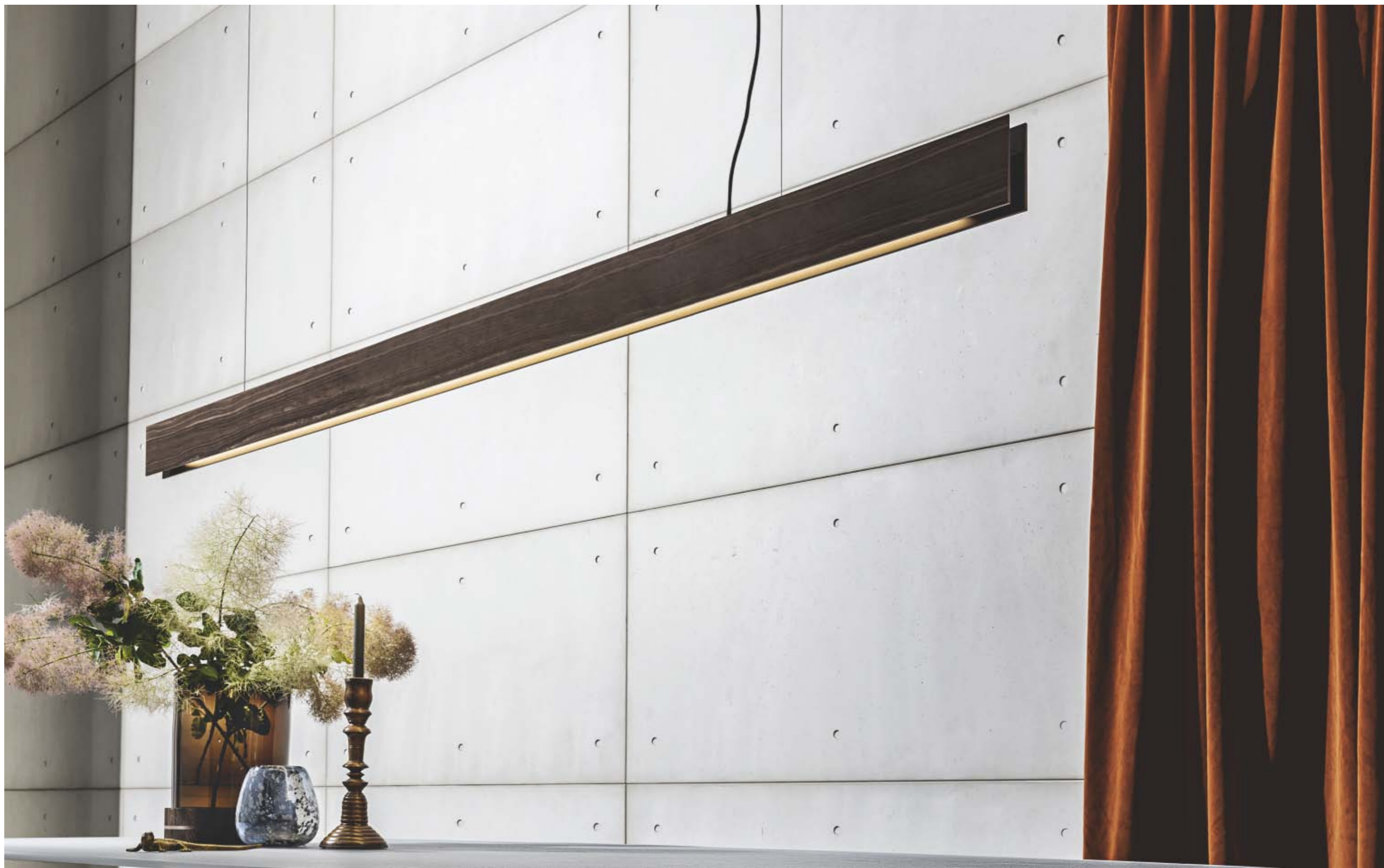



**/ Traled with  
Marquinia  
ceramic sides  
and inside in  
polished brass.**

**/ Traled con  
lati in ceramica  
Marquinia ed  
interno ottone  
lucido.**



**/ Traled with  
Eramosa  
ceramic sides  
and inside  
lacquered in  
black.**

**/ Traled con  
lati in ceramica  
Eramosa ed  
interno laccato  
nero.**



/ **Eramosa ceramic**

/ Ceramica Eramosa



/ **Gold onyx ceramic**

/ Ceramica onice oro



/ **Frosted bronze mirror**

/ Specchio bronzo acidato



/ **Ceramic Ombra di Caravaggio**

/ Ceramica Ombra di Caravaggio

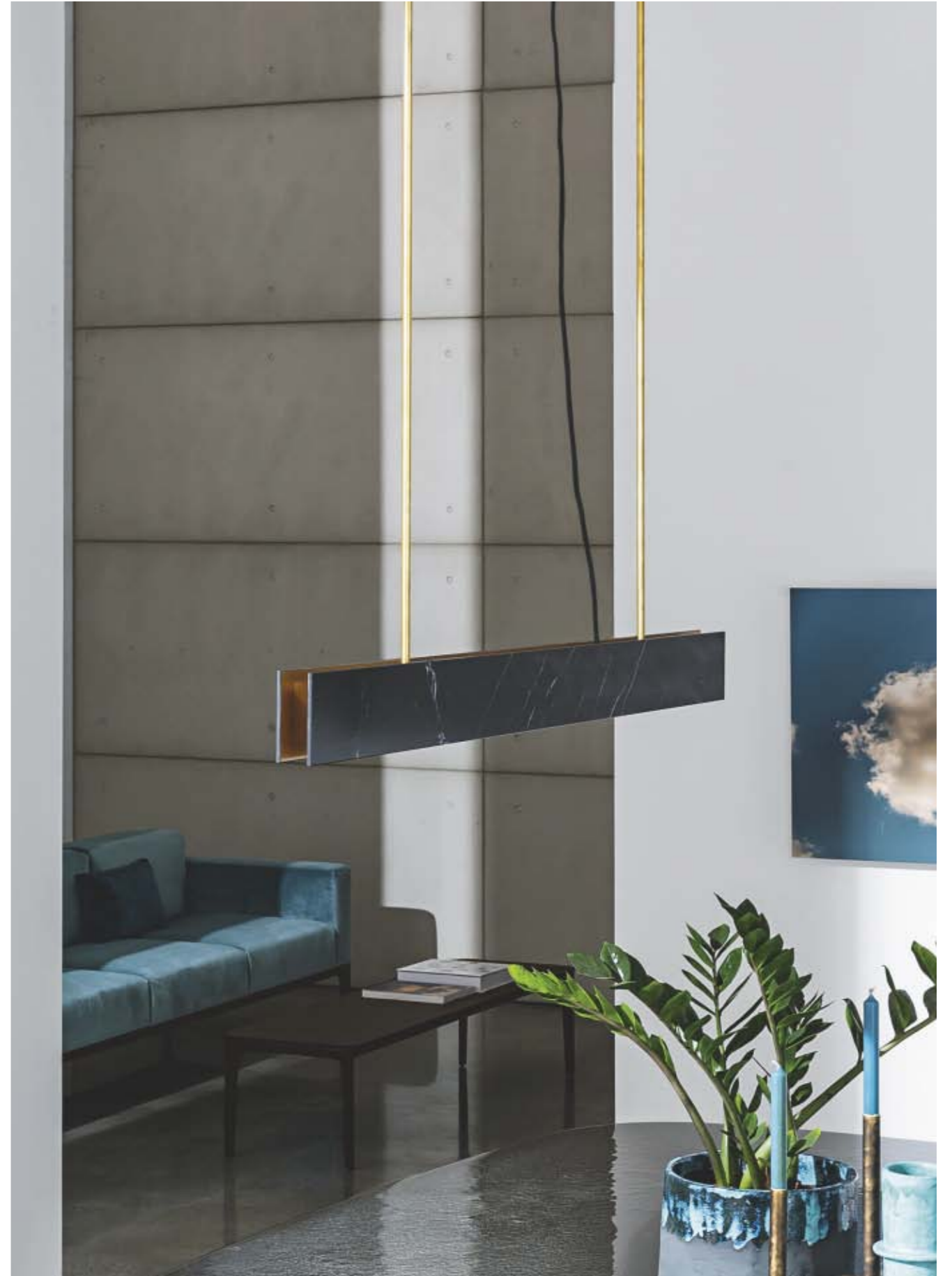

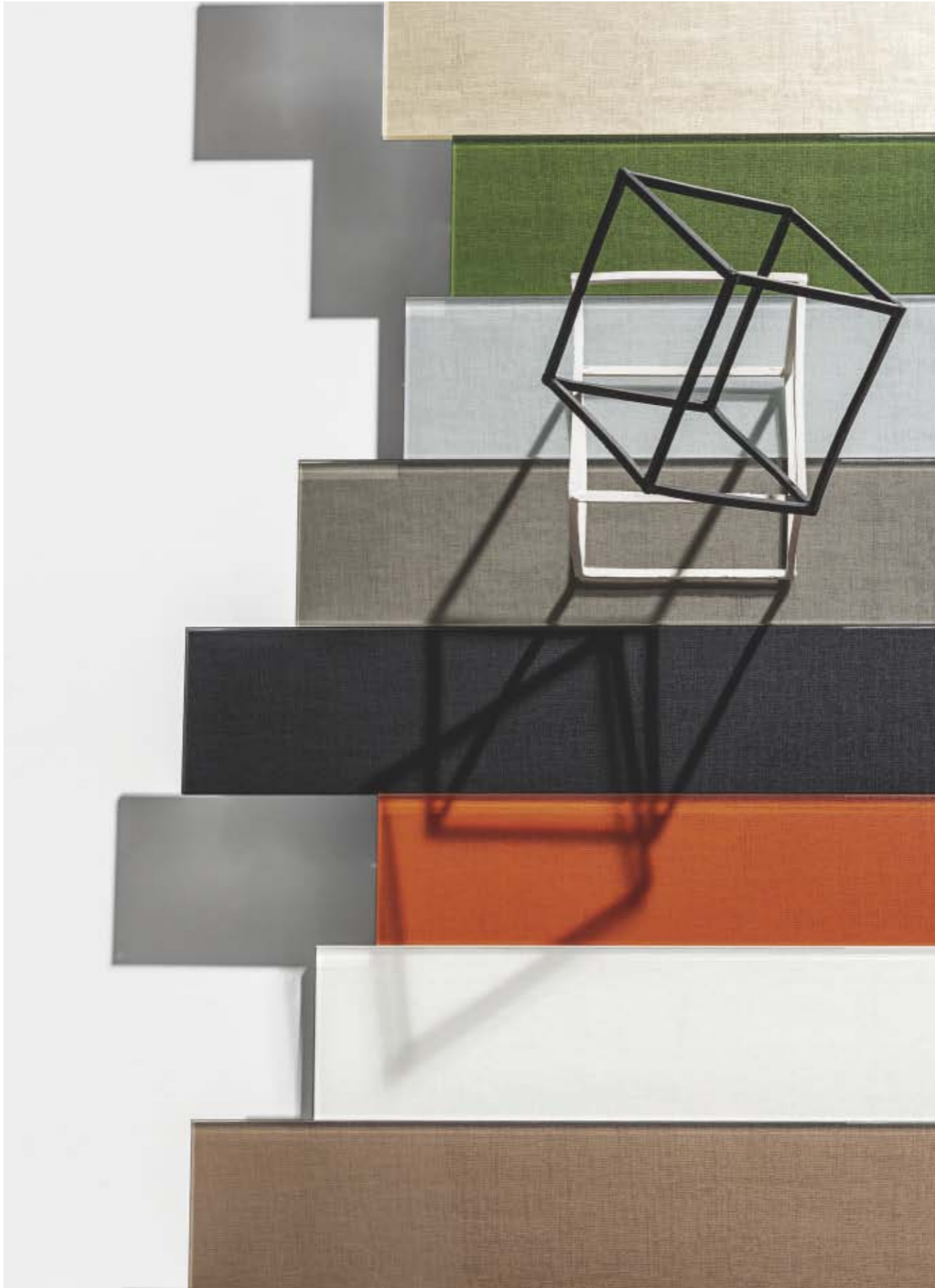

# materials

For its collections Sovet offers a wide range of materials, to explore new textures, material-effect finishes and surfaces, granting a unique completeness of combinations, formal and stylistic, which make a 360 degrees tailor-made furnishing project possible.

Sovet per le proprie collezioni propone un'ampia gamma di materiali, per esplorare nuove texture, finiture materiche e superfici, garantendo una grande completezza di abbinamenti formali e stilistici che consentano un progetto di arredo tailor Made a 360°.



**Glass**  
Vetro



**TETE**

Extralight glass  
Vetro extrachiaro



**TFTF**

Smoked glass  
Vetro fumé



**TBTB**

Bronzed glass  
Vetro bronzo



**TFN1**

Laminated glass  
lacquered black  
Vetro stratificato  
laccato nero



**TEB1**

Extralight  
glass lacquered  
milky white  
Vetro extrachiaro  
laccato bianco  
latte  
**CAT. B**



**TEC1**

Extralight glass  
lacquered mocha  
Vetro extrachiaro  
laccato caffè  
**CAT. B**



**TEC2**

Extralight glass  
lacquered clay  
Vetro extrachiaro  
laccato creta  
**CAT. B**



**TEC3**

Extralight glass  
lacquered cement  
Vetro extrachiaro  
laccato col.  
cemento  
**CAT. B**



**TER4**

Extralight glass  
lacquered rust  
Vetro extrachiaro  
laccato col.  
ruggine  
**CAT. B**



**TEV2**

Extralight  
glass lacquered  
moss green  
Vetro extrachiaro  
laccato col.  
muschio  
**CAT. B**



**TEN1**

Extralight glass  
lacquered black  
Vetro extrachiaro  
laccato nero  
**CAT. B**



**TEM6**

Extralight glass  
lacquered tobacco  
Vetro extrachiaro  
laccato col.  
tabacco  
**CAT. D**



**TES1**

Extralight  
glass lacquered  
champagne  
Vetro extrachiaro  
laccato  
champagne  
**CAT. D**

**Frosted glass**  
Vetro acidato



**AEAE**

Frosted glass  
Vetro acidato



**AEB1**

Frosted white  
glass  
Vetro acidato  
bianco  
**CAT. E**



**AEC1**

Frosted mocha  
glass  
Vetro acidato  
caffé  
**CAT. E**



**AEC2**

Frosted clay glass  
Vetro acidato creta  
**CAT. E**



**AEC3**

Frosted  
cement glass  
Vetro acidato  
col. cemento  
**CAT. E**



**AER4**

Frosted rust glass  
Vetro acidato  
col. ruggine  
**CAT. E**



**AEV2**

Frosted moss  
green glass  
Vetro acidato  
col. muschio  
**CAT. E**



**AEN1**

Frosted  
black glass  
Vetro acidato  
nero  
**CAT. E**



**AEM6**

Frosted tobacco  
glass  
Vetro acidato col.  
tabacco  
**CAT. E**



**AES1**

Frosted  
champagne  
glass  
Vetro acidato  
champagne  
**CAT. E**

**Net glass**



**NENE**

Net glass

**CAT. NE**



**NEB1**

White  
Net glass  
Net glass  
bianco  
**CAT. N**

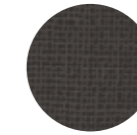

**NEC1**

Mocha  
Net glass  
Net glass  
caffé  
**CAT. N**

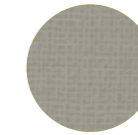

**NEC2**

Clay Net glass  
Net glass creta  
**CAT. N**

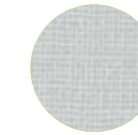

**NEC3**

Cement Net glass  
Net glass col.  
cemento  
**CAT. N**



**NER4**

Rust Net glass  
Net glass  
col. ruggine  
**CAT. N**



**NEV2**

Moss green  
Net glass  
Net glass  
col. muschio  
**CAT. N**



**NEN1**

Black  
Net glass  
Net glass  
nero  
**CAT. N**

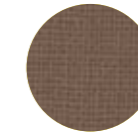

**NEM6**

Tobacco  
Net glass  
Net glass col.  
tabacco  
**CAT. N**



**NES1**

Champagne  
Net glass  
Net glass  
champagne  
**CAT. N**

**Materia**



**MESP**

Pearly  
materia glass  
Vetro materia  
perlato



**MBSP**

Bronzed  
materia glass  
Vetro materia  
bronzo

**Liquid glass**



**LFLF**

Smoked Liquid  
glass



**LBLB**

Bronzed Liquid  
glass

**Mirror**  
Specchio



**SESP**

Extralight  
mirror  
Specchio  
extrachiaro



**SFSP**

Smoked mirror  
Specchio fumé



**SBSP**

Bronzed  
mirror  
Specchio  
bronzo



**SRSP**

Rose mirror  
Specchio rosa



**SOSP**

Gold mirror  
Specchio oro

**Frosted Mirror**  
Specchio Acidato



**SEAC**

Extralight  
frosted mirror  
Specchio  
extrachiaro  
acidato



**SFAC**

Smoked  
frosted mirror  
Specchio fumé  
acidato



**SBAC**

Bronzed  
frosted mirror  
Specchio  
bronzo acidato



**SRAC**

Rose  
frosted mirror  
Specchio rosa  
acidato



**SOAC**

Gold  
frosted mirror  
Specchio oro  
acidato

**Ceramic**  
Ceramica  
Categoria CE1



**CT**

Ceramic titanio  
Ceramica titanio



**CJ**

Ivory black ceramic  
Ceramica Ivory Black



**CD**

Dark ceramic  
Ceramica dark



**CM**

Mocha ceramic  
Ceramica caffè



**CG**

Grey ceramic  
Ceramica grey

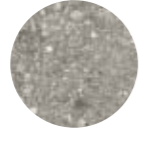

**CZ**

Ceppo di Grè ceramic  
Ceramica Ceppo di Grè

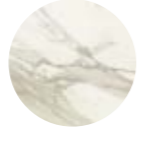

**CC**

Pre-polished Calacatta ceramic  
Ceramica Calacatta Prelucidata

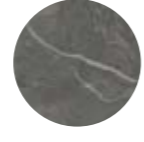

**CX**

Pre-polished Stone Grey ceramic  
Ceramica Stone Grey Prelucidata

**Ceramic**  
Ceramica  
Categoria CE2



**CA**

Arabescato light ceramic  
Ceramica Arabescato light

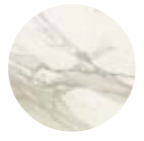

**CL**

Polished Calacatta ceramic  
Ceramica Calacatta lucida



**CY**

Stone grey ceramic  
Ceramica Stone grey



**CU**

Gaudi Stone ceramic  
Ceramica Gaudi Stone

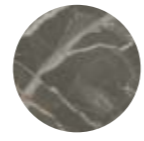

**CV**

Ombra di Caravaggio ceramic  
Ceramica Ombra di Caravaggio



**CH**

Grey onyx ceramic  
Ceramica Grey onyx

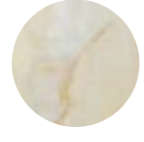

**CI**

Gold Onyx ceramic  
Ceramica Onice oro



**CO**

Portoro ceramic  
Ceramica Portoro

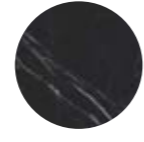

**CQ**

Polished Marquinia ceramic  
Ceramica Marquinia lucida



**CF**

Eramosa ceramic  
Ceramica Eramosa

**Metals**  
Metalli



**GB**

Embossed white  
Bianco goffrato



**GC**

Embossed mocha  
Caffè goffrato



**GT**

Embossed clay  
Creta goffrato



**GN**

Embossed black  
Nero goffrato



**BR**

Burnished metal  
Metallo brunito



**IL**

Polished stainless steel  
Inox lucido

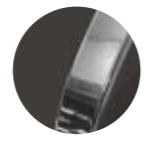

**LC**

Polished chrome  
Cromo lucido



**OA**

Anodized aluminium  
Alluminio anodizzato

**Woods**  
Legni



**NC**

Canaletto walnut  
Noce canaletto



**RN**

Natural oak wood  
Rovere naturale



**RG**

Grey lacquered oak  
Rovere tinto grigio



**WG**

Wengè-stained oak  
Rovere tinto wengè

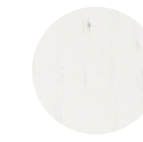

**BI**

Opened pore white-lacquered oak  
Rovere tinto bianco poro aperto

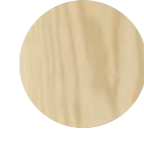

**FF**

Natural ash  
Frassino naturale



**DF**

Black-lacquered ash  
Frassino nero

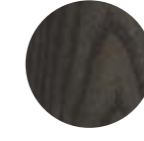

**WF**

Wengè-stained ash  
Frassino tinto wengè

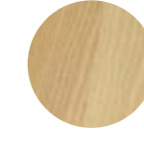

**RF**

Oak-stained ash  
Frassino tinto rovere

**HPL**



**HB**

White black edge  
Bianco bordo nero



**HN**

Black  
Nero



**H4**

White white edge  
Bianco bordo bianco

**Cristalplant**



**CB**

White  
Bianco

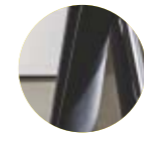

**CN**

Black  
Nero

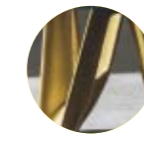

**BR**

Burnished  
Brunito

**Kvadrat  
Hallingdal 65**

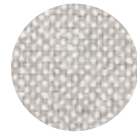

103

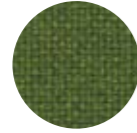

960

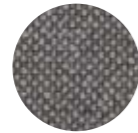

153



764

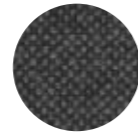

173



590

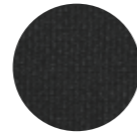

190



674



390

**Gabriel  
Trevira CS**

**Step**



F10

Beige  
Beige

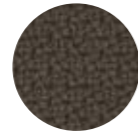

F11

Mocha  
Caffè



F12

Black  
Nero

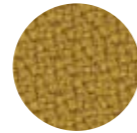

F13

Mustard  
Senape

**Step melange**

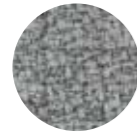

F01

Grey  
Grigio



F02

Avio  
Avio



F03

Dark Teal  
Ottanio scuro

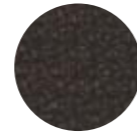

F04

Dark Brown  
Marrone testa  
di moro

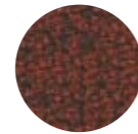

F05

Carmin  
Carminio

**Velvet  
Velluto**

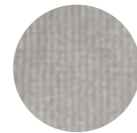

Z01

Light grey  
Grigio chiaro

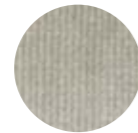

Z02

Khaki  
Cachi



Z03

Taupe color  
Color talpa

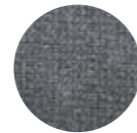

Z04

Grey  
Grigio



Z05

Anthracite  
Antracite

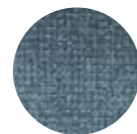

Z06

Light blue  
Azzurro



Z08

Yellow  
Giallo

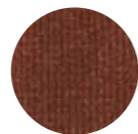

Z09

Brick red  
Rosso mattone

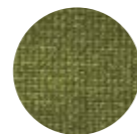

Z10

Olive green  
Verde oliva

**Leather  
Pelle**



P50

White  
Bianco



P63

Off-white  
Panna

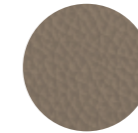

P64

Umber  
Terra

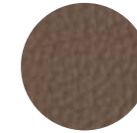

P61

Brown  
Marrone

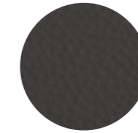

P54

Mocha  
Caffè

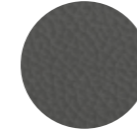

P65

Grey  
Grigio



P53

Black  
Nero

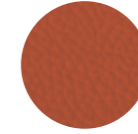

P66

Orange  
Arancione

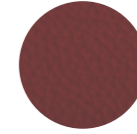

P62

Burgundy  
Borgogna

**Fake Leather  
Ecopelle**



E01

White  
Bianco



E02

Off - White  
Panna



E03

Red  
Rosso



E04

Black  
Nero



E05

Mocha  
Caffè

**Rebel Nabuk  
Fake Leather  
Ecopelle Nabuk  
Rebel**



R21

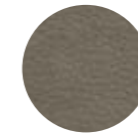

R23

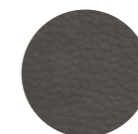

R25

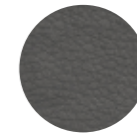

R26



# notes

The shade of the samples is only indicative and has not to be taken as restrictive. It can in fact slightly differ in conformity to the tolerances recognized for the materials used.

La tonalità dei campioni proposti è indicativa e non va pertanto intesa in senso restrittivo, può infatti differire leggermente in conformità ai margini di tolleranza riconosciuti per i materiali impiegati.

**So.ve.t**  
**Società Vetraria Trevigiana Srl Unipersonale**  
**Via Emilio Salgari, 1/A**  
**31056 Biancade, Treviso – Italy**

**tel +39 0422 848030**  
**fax +39 0422 848032**  
**sovet@sovet.com**  
**sovet.com**

**Concept & Art direction**  
GIANLUIGI LANDONI

**Photography**  
LORENZO PENNATI

**Graphic design**  
ALTRODESIGN

**Stylist**  
ROSARIA SOFIA GALLI

**Text**  
SOVET

**Color correction**  
SARTORI

**Thanks to:**  
ADRIANA ALBERTINI  
BOSA  
SIMONA CARDINETTI  
EMMEBI MESA  
ILARIA FRANZA  
ITINERARI by Altrodesign  
MARIA LA ROSA  
MUN by VGnewtrend  
LEONARDO/MERITO  
LLADRÒ  
MESSULAM  
SALVATORI  
SELETTI

**Printing**  
GRAFICHE GFP

The pictures and texts in this catalogue are of exclusive property of SOVET. Reproduction, by whatever means, is forbidden.

Le immagini ed i contenuti riportati nel presente catalogo si intendono di proprietà esclusiva di SOVET, pertanto è vietato qualsiasi tipo di riproduzione.

Edizione 2020

**AZIENDA CERTIFICATA UNI EN ISO 9001**

CERTIFIED QUALITY SYSTEM UNI EN ISO 9001

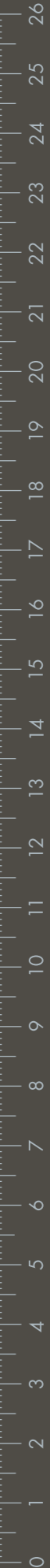

Sovet was born at the end of the '80s to explore the expression possibilities of glass in the contemporary furnishing. Since the beginning of the years 2000 it starts the collaboration with important international designers and introduces other materials alongside glass, widening its perspective under the sign of creativity and continuous evolution. From "New shapes for glass" to "New shapes for design", in the last 30 years the company has undergone a constant growth, transforming itself from a company identified with glass to an internationally successful 360-degree design company, with new solutions both for home and contract environment which combine minimalism and an accurate materials selection.